

Modelli

Models

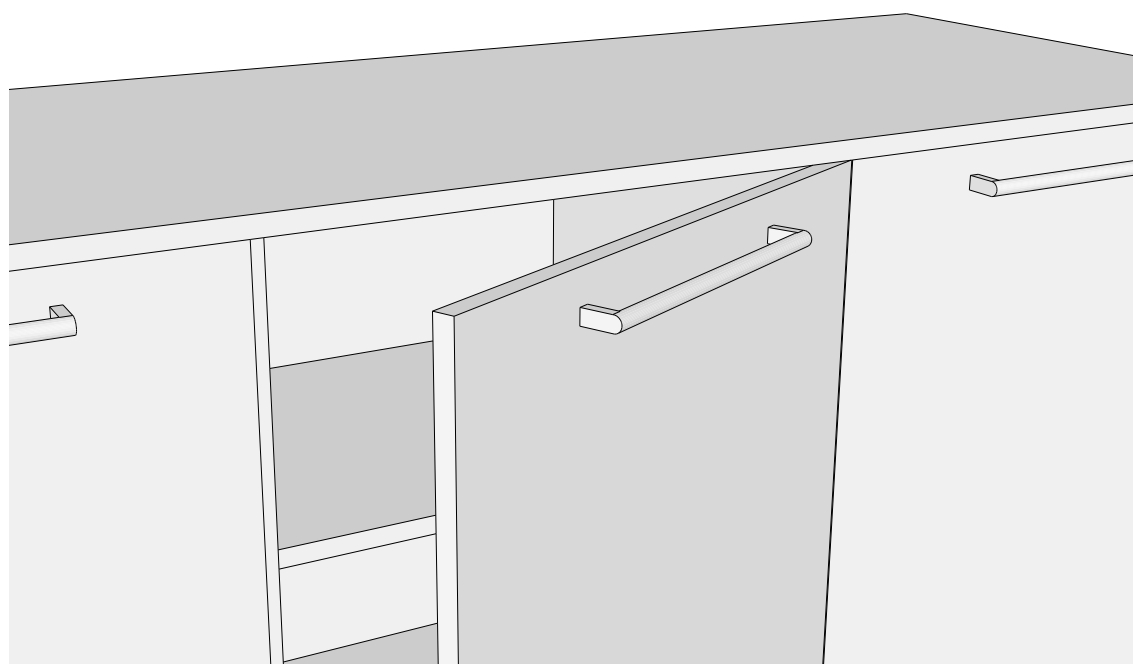

Sezione ante
Door section



Anta di spessore 19 mm bordata 4 lati.
 Frontali in nobilitato bifacciale con bordo abs in tinta sui 4 lati.
 Frontali in mdf laccato opaco monofacciale con bordo abs in tinta sui 4 lati. Lato interno in tinta.
 Frontali in mdf laccato lucido UV monofacciale con bordo abs in tinta sui 4 lati. Lato interno in tinta (ad eccezione della variante Grigio pepe che ha l'interno bianco).

FIANCHI PERSONALIZZATI IN FINITURA ANTA (per maggiorazioni vedi capitolo PERSONALIZZAZIONI).
 FIANCHI A C TERMINALI CON GOLA (vedi pag. 104)
 PENSILI ABBINABILI CON MANIGLIA O FONDO GOLA.

19 mm thick 4-side edged doors.
 Doors and drawers made by double-face chipboard melamine panels; matching abs edge on four sides.
 Doors and drawers made by one-face matt lacquered mdf panels; matching abs edge on four sides. Matching colour inner side.
 Doors and drawers made by one-face UV glossy lacquered mdf panels; matching abs edge on four sides. Inner side is in white melamine on Bianco ottico and Grigio pepe finishes. On Paglia, Rosso lampone and Grigio scoglio finishes the inner side is always in matching melamine colour.

OPTIONAL MATCHING COLOUR SIDE PANELS ARE AVAILABLE (for extra charges see CUSTOMIZATION chapter).
 GROOVE AND "C" SIDE PANEL (see pag. 104)
 WALL UNITS AVAILABLE WITH HANDLE OR WITH GROOVE BOTTOM.

Misure ante | Door measures

Misure disponibili per ante (basi e pensili e colonne)
 Available measures for doors (base and wall and tall units)

	H 117	H 177	H 237	H 357	H 477	H 597	H 717	H 957	H 1197	H 1317	H 1557	H 2037	H 2277
L 147													
L 297													
L 397													
L 447													
L 597													
L 747													
L 897													
L 1197													
L 1497													
L 1797													

 Misure disponibili Available measures

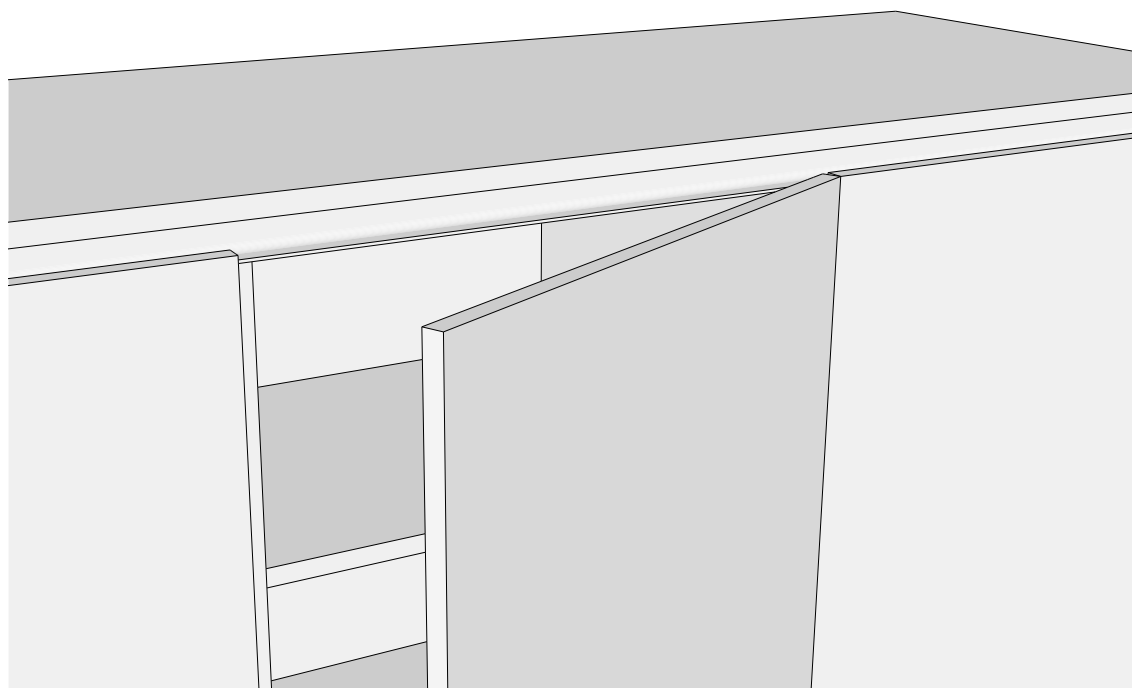

Sezione ante
Door section



Anta di spessore 19 mm bordata 4 lati.

Frontali in nobilitato bifacciale con bordo abs in tinta sui 4 lati.

Frontali in mdf laccato opaco monofacciale con bordo abs in tinta sui 4 lati. Lato interno in tinta.

Frontali in mdf laccato lucido UV monofacciale con bordo abs in tinta sui 4 lati. Lato interno in tinta (ad eccezione della variante Grigio pepe che ha l'interno bianco).

FIANCHI PERSONALIZZATI IN FINITURA ANTA (per maggiorazioni vedi capitolo PERSONALIZZAZIONI).

FIANCHI A C TERMINALI CON GOLA (vedi pag. 104)

PENSILI ABBINABILI CON FONDO GOLA.

19 mm thick 4-side edged doors.

Doors and drawers made by double-face chipboard melamine panels; matching abs edge on four sides.

Doors and drawers made by one-face matt lacquered mdf panels; matching abs edge on four sides. Matching colour inner side.

Doors and drawers made by one-face UV glossy lacquered mdf panels; matching abs edge on four sides. Inner side is in white melamine on Bianco ottico and Grigio pepe finishes. On Paglia, Rosso lampone and Grigio scoglio finishes the inner side is always in matching melamine colour.

OPTIONAL MATCHING COLOUR SIDE PANELS ARE AVAILABLE (for extra charges see CUSTOMIZATION chapter).

GROOVE AND "C" SIDE PANEL (see pag. 104)

WALL UNITS AVAILABLE WITH HANDLE OR WITH GROOVE BOTTOM.

Misure ante | Door measures

Misure disponibili per ante (basi e pensili e colonne)

Available measures for doors (base and wall and tall units)

	H 117	H 147	H 177	H 237	H 327	H 357	H 477	H 597	H 717	H 957	H 1197	H 1317	H 1557	H 2037	H 2277
L 147															
L 297															
L 397															
L 447															
L 597															
L 747															
L 897															
L 1197															
L 1497															
L 1797															

■ Misure disponibili Available measures

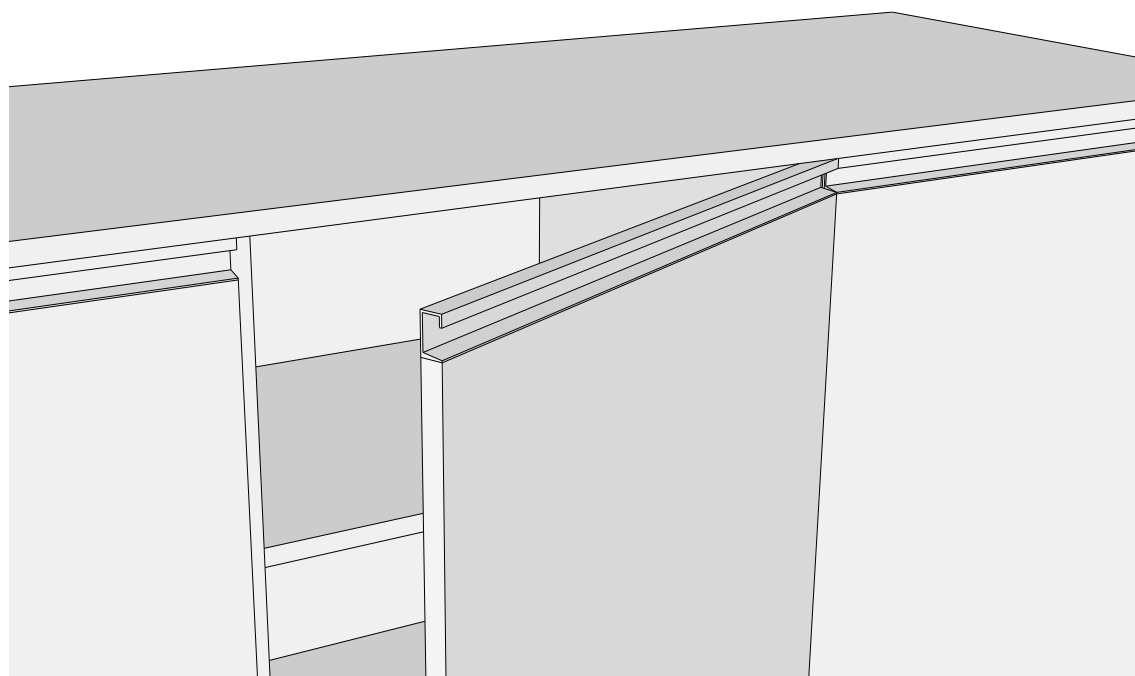

Sezione ante
Door section

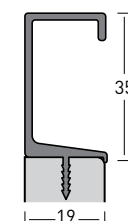

Anta di spessore 19 mm bordata 3 lati e 1 lato con maniglia integrata.
 Frontali in nobilitato bifacciale con bordo abs in tinta sui 3 lati.
 Frontali in mdf laccato opaco monofacciale con bordo abs in tinta sui 3 lati. Lato interno in tinta.
 Frontali in mdf laccato lucido UV monofacciale con bordo abs in tinta sui 4 lati. Lato interno in tinta (ad eccezione della variante Grigio pepe che ha l'interno bianco).

FIANCHI PERSONALIZZATI IN FINITURA ANTA (per maggiorazioni vedi capitolo PERSONALIZZAZIONI).
 PENSILI ABBINABILI CON FONDO GOLA.

19 mm thick 3-side edged doors and one with integrated handle.
 Doors and drawers made by double-face chipboard melamine panels; matching abs edge on four sides.
 Doors and drawers made by one-face matt lacquered mdf panels; matching abs edge on four sides. Matching colour inner side.
 Doors and drawers made by one-face UV glossy lacquered mdf panels; matching abs edge on four sides. Inner side is in white melamine on Bianco ottico and Grigio pepe finishes. On the other finishes the inner side is always in matching melamine colour.

OPTIONAL MATCHING COLOUR SIDE PANELS ARE AVAILABLE (for extra charge see CUSTOMIZATION chapter).
 WALL UNITS AVAILABLE WITH GROOVE BOTTOM.

Misure ante | Door measures

Misure disponibili per ante (basi e pensili e colonne)
 Available measures for doors (base and wall and tall units)

	H 177	H 237	H 357	H 477	H 597	H 717	H 957	H 1197	H 1317	H 1557	H 2037	H 2277
L 147												
L 297												
L 397												
L 447												
L 597												
L 747												
L 897												
L 1197												

■ Misure disponibili Available measures

Sovrapprezzo | Surcharges



Maniglia COLIBRÌ PRESA
 COLIBRÌ PRESA handle



■ Metal ■ Nero spazzolato

L. W.	Orizzontale Horizontal	Sovrapprezzo Surcharges
da 15 a 60 cm		+ 15
da 75 a 120 cm		+ 23
H. H.	Verticale Vertical	Sovrapprezzo Surcharges
da 24 a 72 cm		+ 15
da 96 a 132 cm		+ 23
da 156 a 228 cm		+ 30

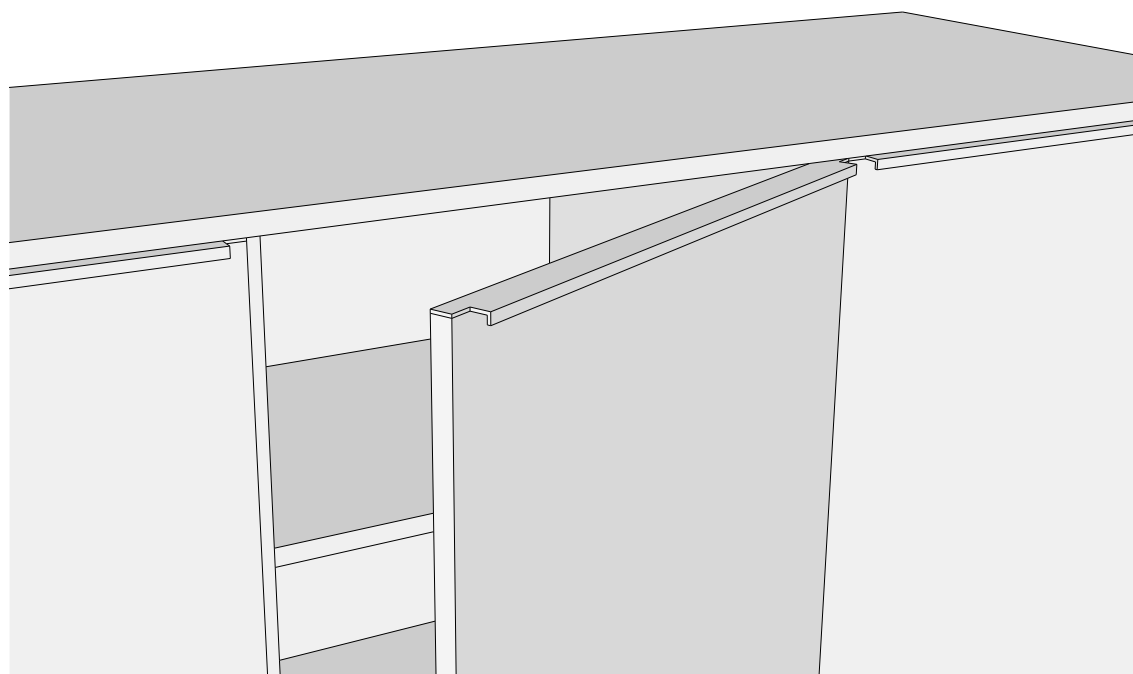

Sezione anta
Door section

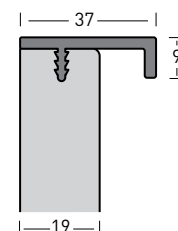

Anta di spessore 19 mm bordata 3 lati e 1 lato con maniglia integrata.

Frontali in nobilitato bifacciale con bordo abs in tinta sui 3 lati.

Frontali in mdf laccato opaco monofacciale con bordo abs in tinta sui 3 lati. Lato interno in tinta.

Frontali in mdf laccato lucido UV monofacciale con bordo abs in tinta sui 4 lati. Lato interno in tinta (ad eccezione della variante Grigio pepe che ha l'interno bianco).

FIANCHI PERSONALIZZATI IN FINITURA ANTA (per maggiorazioni vedi capitolo PERSONALIZZAZIONI).

PENSILI ABBINABILI CON FONDO GOLLA.

I FRONTALI NON SONO RIDUCIBILI SUL LATO CON MANIGLIA INTEGRATA.

19 mm thick 3-side edged door and one side with integrated handle.

Doors and drawers made by double-face chipboard melamine panels; matching abs edge on 3 sides.

Doors and drawers made by one-face matt lacquered mdf panels; matching abs edge on 3 sides. Matching colour inner side.

Doors and drawers made by one-face UV glossy lacquered mdf panels; matching abs edge on 3 sides. Inner side is in white melamine on Bianco ottico and Grigio pepe finishes. On Paglia, Rosso lampone and Grigio scoglio finishes the inner side is always in matching melamine colour.

OPTIONAL MATCHING COLOUR SIDE PANELS ARE AVAILABLE (for extra charge see CUSTOMIZATION chapter).

WALL UNITS AVAILABLE WITH GROOVE BOTTOM.

DOORS and DRAWERS CANNOT BE CUTTED ON THE SIDE WITH INTEGRATED HANDLE.

Misure ante | Door measures

Misure disponibili per ante (basi e pensili e colonne)

Available measures for doors (base and wall and tall units)

	H 117	H 177	H 237	H 357	H 477	H 597	H 717	H 957	H 1197	H 1317	H 1557
L 147											
L 297											
L 397											
L 447											
L 597											
L 747											
L 897											
L 1197											

Misure disponibili Available measures

Sovrapprezzo | Surcharges



Maniglia COLIBRÌ INTRA
COLIBRÌ INTRA handle



Nero supermatt

L. W.	Orizzontale Horizontal	Sovrapprezzo Surcharges
da 15 a 60 cm		+ 15
da 75 a 120 cm		+ 23

0 Fascia | Group

Nobilitato tinta unita

Melamine colour

A Categoria fianco finitura anta
Frame finishing side category

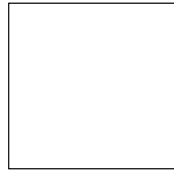

Bianco latte

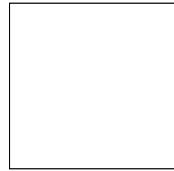

Corda

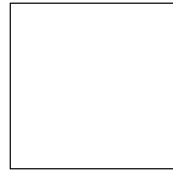

Canapa

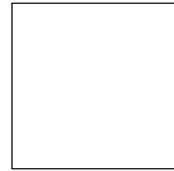

Seppia

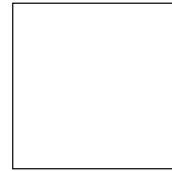

Cacao

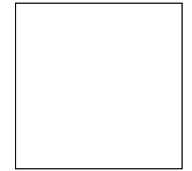

Grigio tela

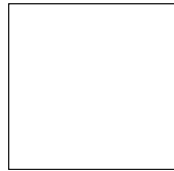

Grigio intenso

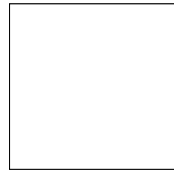

Verde foglia

1 Fascia | Group

Nobilitato legno

???

A Categoria fianco finitura anta
Frame finishing side category

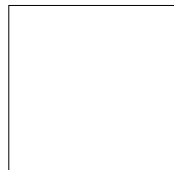

Noce rio

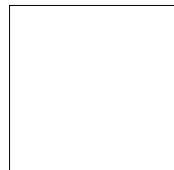

Rovere biondo

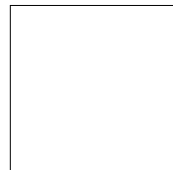

Noce nordico

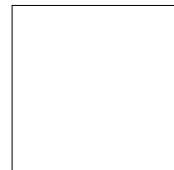

Olmo tabacco

Nobilitato cemento

???

A Categoria fianco finitura anta
Frame finishing side category



Cemento white

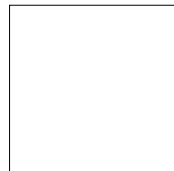

Cemento brown

2 Fascia | Group

Nobilitato metallo
Melamine - Metal

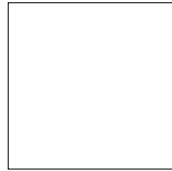

Ottone



Titanio

C Categoria fianco finitura anta
Frame finishing side category

Laccato opaco monofacciale
(interno in tinta)

Matt one-side lacquered
(interior in matching color)

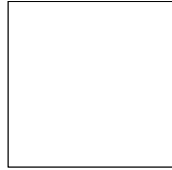

Bianco giappone

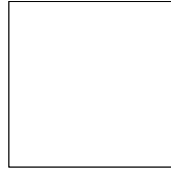

Sabbia

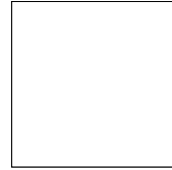

Tortora nevada

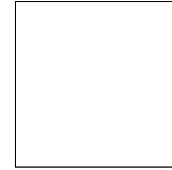

Moca

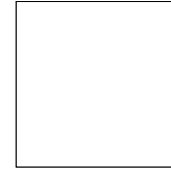

Rosso madeira

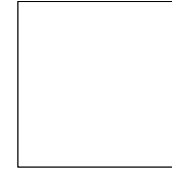

Blu capri

B Categoria fianco finitura anta
Frame finishing side category

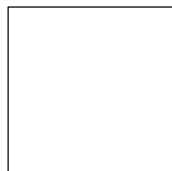

Menta



Aloe



Grigio caldo

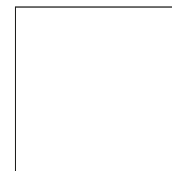

Grigio irlandia

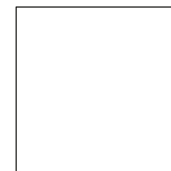

Nero texas

Laccato lucido UV monofacciale
(interno in tinta eccetto*)

Glossy one-side UV lacquered
(interior in matching color except*)

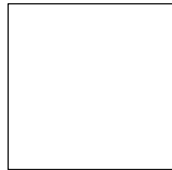

Bianco ottico

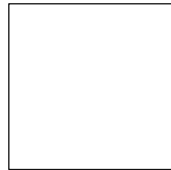

Paglia

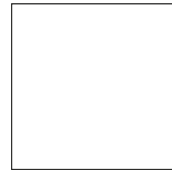

Cioccolato

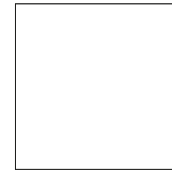

Verde foresta

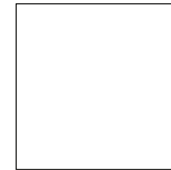

Grigio scoglio

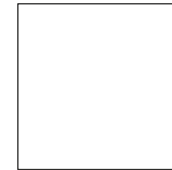

Grigio pepe*

B Categoria fianco finitura anta
Frame finishing side category

Spessore Thickness **22 mm**

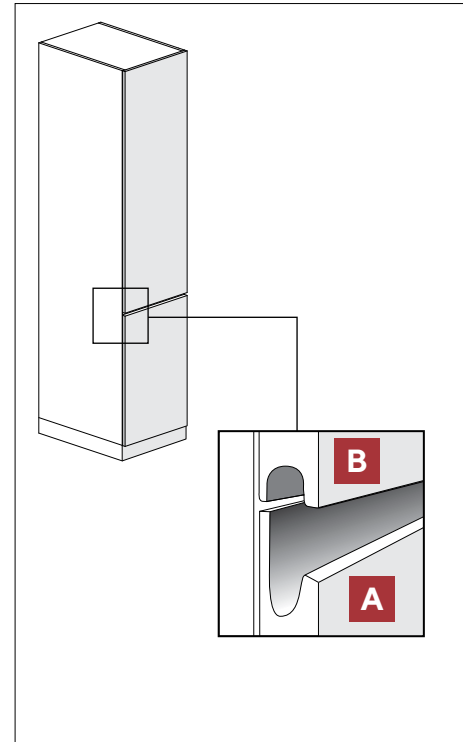
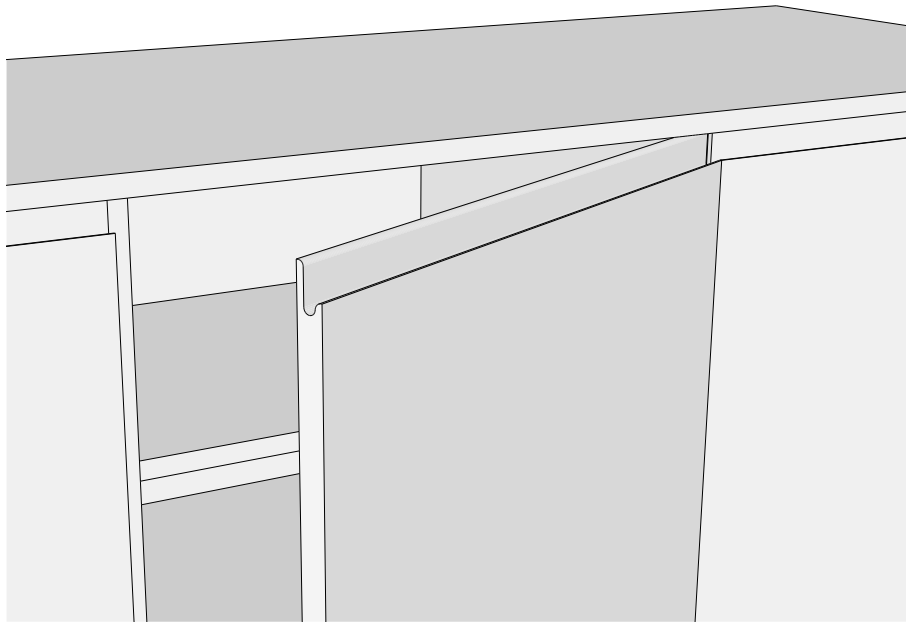

Sezione ante
Door section

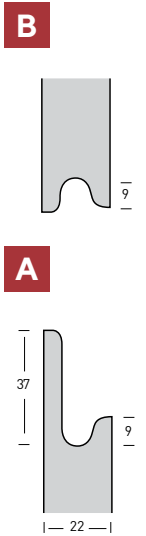

Anta di spessore 22 mm bordata 3 lati e 1 lato con maniglia integrata con sagoma a J.
Frontali in mdf rivestito in PET con incavo a J per apertura ricavato nel bordo superiore.
Frontale superiore per colonne con contromaniglia nel lato inferiore.

FIANCHI PERSONALIZZATI IN FINITURA ANTA (per maggiorazioni vedi capitolo PERSONALIZZAZIONI).
PENSILI ABBINABILI CON FONDO GOLA.

**ATTENZIONE: I PENSILI DEVONO ESSERE CONTEGGIATI IN FASCIA 3.
FRONTALI NON RIDUCIBILI A MISURA SUL LATO MANIGLIA.**

22 mm thick 3-side edged door and one side with J-shape integrated handle.
Doors and drawers made by double-face melamine or PET wrapped mdf panels; J shaped handle milling for opening on upper side.
On tall units the upper door have the lower side with a counter handle milling.

OPTIONAL MATCHING COLOUR SIDE PANELS ARE AVAILABLE (for extra charge see CUSTOMIZATION chapter).
WALL UNITS AVAILABLE WITH GROOVE BOTTOM.

**WARNING: WALL UNITS HAVE TO BE CONSIDERED WITH THE PRICE OF GROUP 3.
NO COSTOM SIZE IS ALLOWED ON HANDLE SIZE.**

Misure ante (frontale inferiore)

Door measure (bottom door)

Misure disponibili per ante (basi, pensili e colonne)
Available measures for doors (base and wall and tall units)

	H 177	H 237	H 357	H 417	H 597	H 777	H 957	H 1317
L 147								
L 297								
L 397								
L 447								
L 597								
L 747								
L 897								
L 1197								

Misure ante (frontale superiore con contromaniglia)

Door measure (upper door with counter handle)

Misure disponibili per ante (basi, pensili e colonne)
Available measures for doors (base and wall and tall units)

	H 717	H 957	H 1317
L 147			
L 297			
L 397			
L 447			
L 597			
L 747			

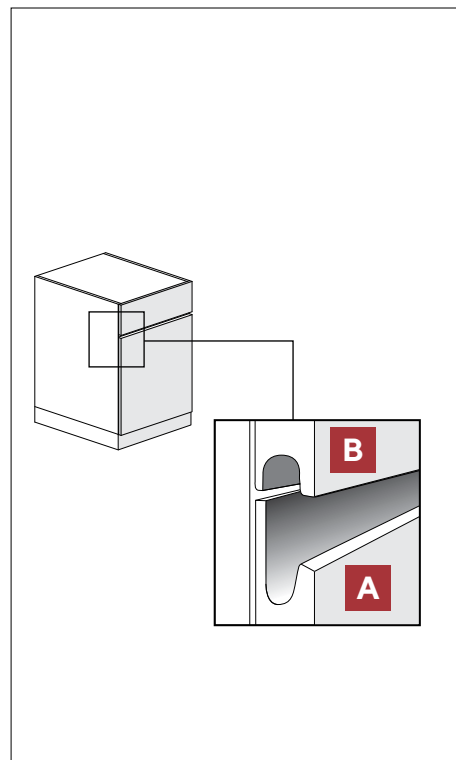
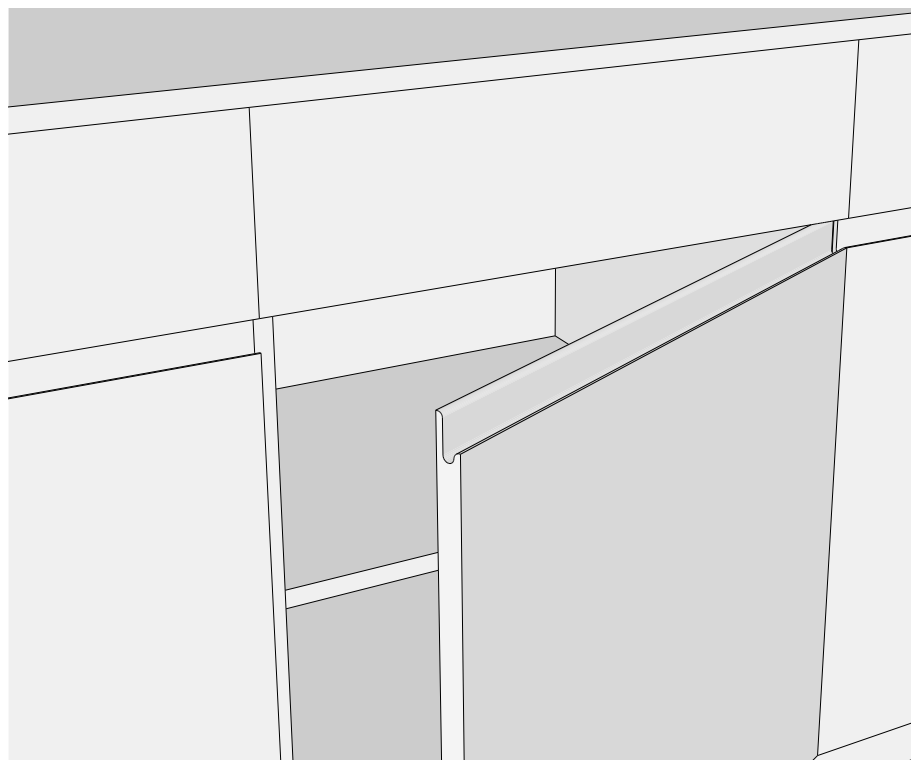

Sezione ante
Door section

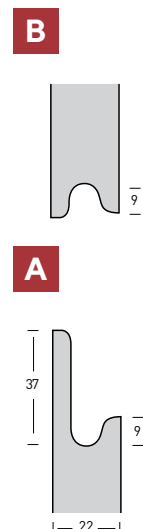

Anta di spessore 22 mm bordata 3 lati e 1 lato con maniglia integrata con sagoma a J.
Frontali in mdf rivestito in PET con incavo a J per apertura ricavato nel bordo superiore.
Frontale superiore per basi e colonne con contromaniglia nel lato inferiore.

FIANCHI PERSONALIZZATI IN FINITURA ANTA (per maggiorazioni vedi capitolo PERSONALIZZAZIONI).
PENSILI ABBINABILI CON FONDO GOLA.

**ATTENZIONE: I PENSILI DEVONO ESSERE CONTEGGIATI IN FASCIA 3.
FRONTALI NON RIDUCIBILI A MISURA SUL LATO MANIGLIA.**

22 mm thick 3-side edged door and one side with J-shape integrated handle.
Doors and drawers made by double-face melamine or PET wrapped mdf panels; J shaped handle milling for opening on upper side.
On tall units the upper door have the lower side with a counter handle milling.

OPTIONAL MATCHING COLOUR SIDE PANELS ARE AVAILABLE (for extra charge see CUSTOMIZATION chapter).
WALL UNITS AVAILABLE WITH GROOVE BOTTOM.

**WARNING: WALL UNITS HAVE TO BE CONSIDERED WITH THE PRICE OF GROUP 3.
NO COSTOM SIZE IS ALLOWED ON HANDLE SIZE.**

Misure ante (frontale inferiore)

Door measure (bottom door)

Misure disponibili per ante (basi e colonne)
Available measures for doors (base and wall and tall units)

	H 177	H 357	H 417	H 597
L 147				
L 297				
L 397				
L 447				
L 597				
L 747				
L 897				
L 1197				

Misure ante (frontale superiore con contromaniglia)

Door measure (upper door with counter handle)

Misure disponibili per ante (pensili e colonne)
Available measures for doors (base and wall and tall units)

	H 177	H 357	H 597	H 717	H 957
L 147					
L 297					
L 397					
L 447					
L 597					
L 747					

2 Fascia | Group

Seta Bifacciale
Silk Both faced

B Categoria fianco finitura anta
Frame finishing side category



Talco seta



Polvere seta



Mandorla seta



Castano seta

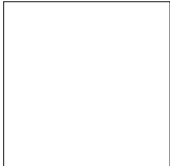

Zinco seta

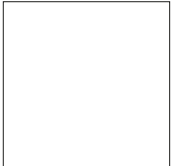

Perla seta



Torba seta



Nero seta

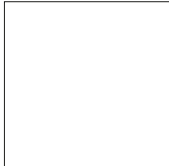

Verde petrolio seta

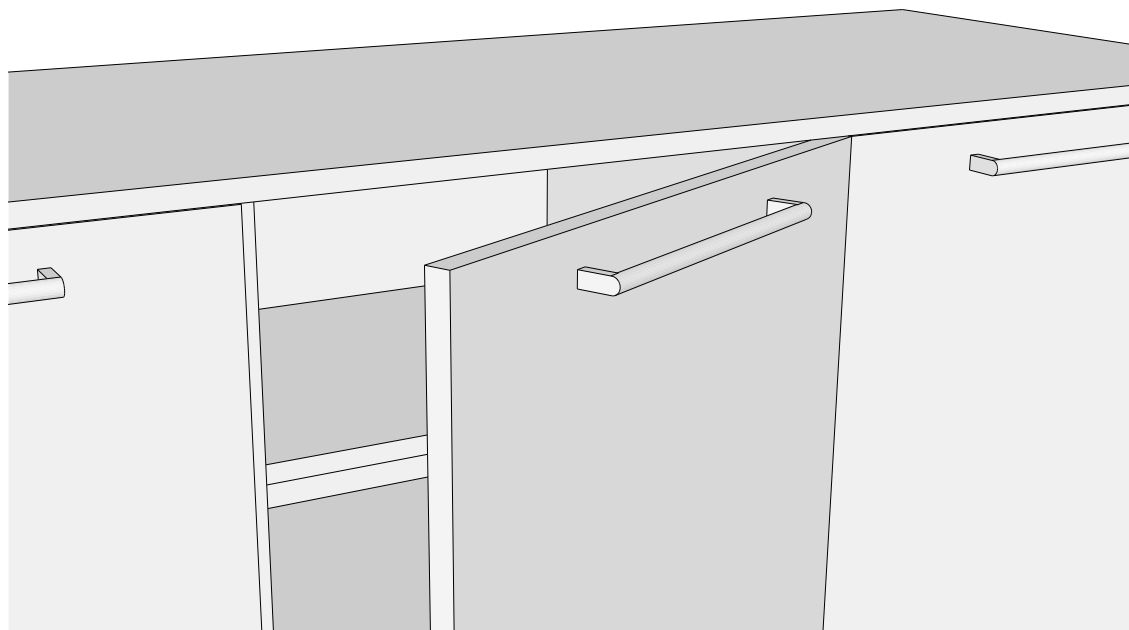

Sezione ante
Door section



Anta di spessore 22 mm bordata 4 lati.

Frontali in nobilitato bifacciale con bordo abs in tinta sui 4 lati.

Frontali in mdf rivestito lato esterno in PET effetto seta e lato interno melaminico in tinta con bordo in abs in tinta sui 4 lati.

Frontali in mdf rivestito due lati in fenix con bordo in abs in tinta sui 4 lati.

Frontali in mdf postformato e laccato in finitura opaca o lucida. Interno in tinta sempre laccato opaco.

FIANCHI PERSONALIZZATI IN FINITURA ANTA (per maggiorazioni vedi capitolo PERSONALIZZAZIONI).

FIANCHI A C TERMINALI CON GOLA (vedi pag. 104)

PENSILI ABBINABILI CON MANIGLIA O CON FONDO GOLA.

22 mm thick 4-side edged door.

Doors and drawers made by double-face melamine panels; matching ABS edge on 4 sides.

Doors and drawers made by chipboard panels with external face in silk effect PET foil and internal face in matching melamine; matching abs edge on 4 sides.

Doors and drawers made by chipboard panels with double-face fenix foil; matching abs edge on 4 sides.

Doors and drawers made by postformed mdf lacquered panels in matt or glossy finish; internal face in matching matt finish.

OPTIONAL MATCHING COLOUR SIDE PANELS ARE AVAILABLE (for extra charge see CUSTOMIZATION chapter).

GROOVE AND "C" SIDE PANEL (see pag. 104)

WALL UNITS AVAILABLE WITH HANDLE OR GROOVE BOTTOM.

Misure ante | Door measures

Misure disponibili per ante (basi e pensili e colonne)

Available measures for doors (base and wall and tall units)

	H 117	H 177	H 237	H 357	H 417	H 477	H 597	H 717	H 777	H 957	H 1197	H 1317	H 1377	H 1557	H 2037	H 2097	H 2277	H 2337
L 147																		
L 297																		
L 397																		
L 447																		
L 597																		
L 747																		
L 897																		
L 1197																		
L 1497																		
L 1797																		

 Misure disponibili Available measures

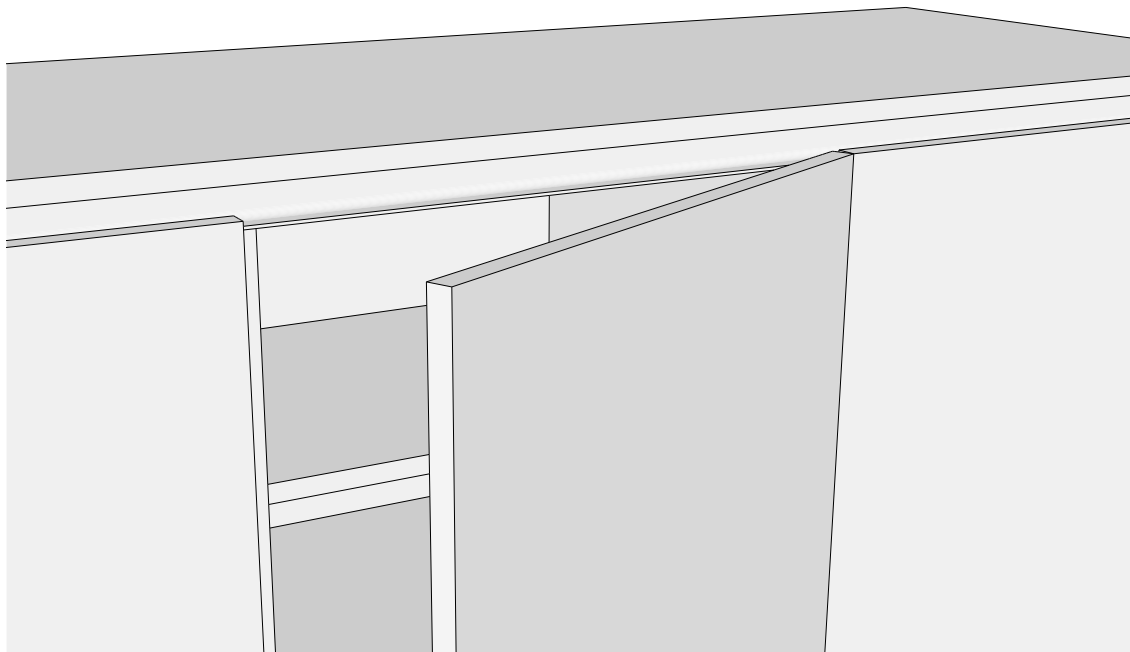

Sezione ante
Door section

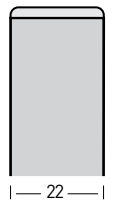

Anta di spessore 22 mm bordata 4 lati.

Frontali in nobilitato bifacciale con bordo abs in tinta sui 4 lati.

Frontali in mdf rivestito lato esterno in PET effetto seta e lato interno melaminico in tinta con bordo in abs in tinta sui 4 lati.

Frontali in mdf rivestito due lati in fenix con bordo in abs in tinta sui 4 lati.

Frontali in mdf postformato e laccato in finitura opaca o lucida. Interno in tinta sempre laccato opaco.

FIANCHI PERSONALIZZATI IN FINITURA ANTA (per maggiorazioni vedi capitolo PERSONALIZZAZIONI).

FIANCHI A C TERMINALI CON GOLA (vedi pag. 104)

PENSILI ABBINABILI CON FONDO GOLA.

22 mm thick 4-side edged door.

Doors and drawers made by double-face melamine panels; matching ABS edge on 4 sides.

Doors and drawers made by chipboard panels with external face in silk effect PET foil and internal face in matching melamine; matching abs edge on 4 sides.

Doors and drawers made by chipboard panels with double-face fenix foil; matching abs edge on 4 sides.

Doors and drawers made by postformed mdf lacquered panels in matt or glossy finish; internal face in matching matt finish.

OPTIONAL MATCHING COLOUR SIDE PANELS ARE AVAILABLE (for extra charge see CUSTOMIZATION chapter).

GROOVE AND "C" SIDE PANEL (see pag. 104)

WALL UNITS AVAILABLE WITH HANDLE OR GROOVE BOTTOM.

Misure ante | Door measures

Misure disponibili per ante (basi, pensili e colonne)

Available measures for doors (base and wall and tall units)

	H 117	H 147	H 177	H 237	H 327	H 357	H 417	H 477	H 597	H 717	H 777	H 957	H 1197	H 1317	H 1377	H 1557	H 2037	H 2277	H 2097	H 2337	
L 147																					
L 297																					
L 397																					
L 447																					
L 597																					
L 747																					
L 897																					
L 1197																					
L 1497																					
L 1797																					

■ Misure disponibili Available measures

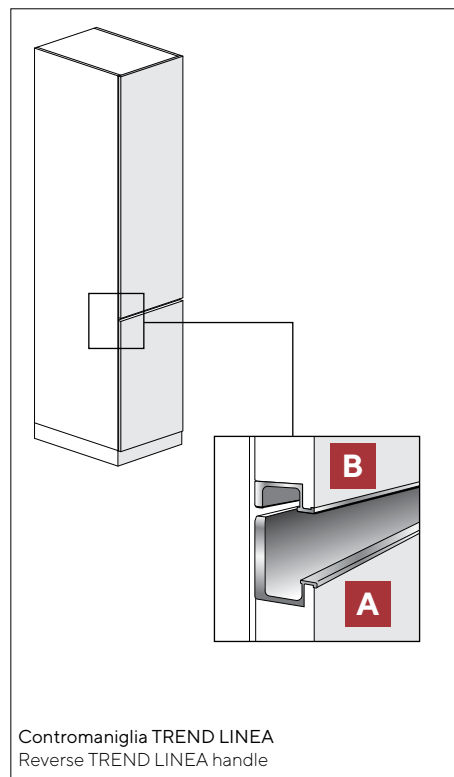
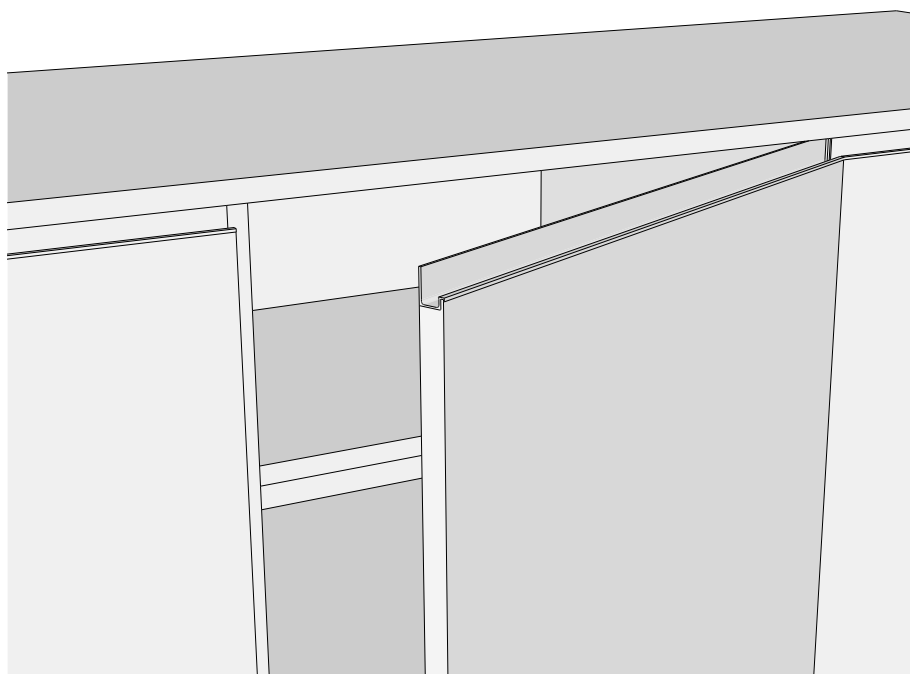

Sezione ante
Door section

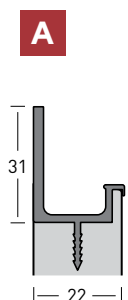
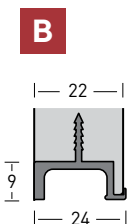

Anta di spessore 22 mm bordata 3 lati e 1 lato con maniglia integrata.
Frontali in nobilitato bifacciale con bordo abs in tinta sui 3 lati.
Frontali in mdf rivestito lato esterno in PET effetto seta e lato interno melaminico in tinta con bordo in abs in tinta sui 3 lati.
Frontali in mdf rivestito due lati in fenix con bordo in abs in tinta sui 3 lati.
Frontali in mdf postformato con fondo poliesterato e laccato in finitura opaca o lucida. Interno in tinta sempre laccato opaco.

FIANCHI PERSONALIZZATI IN FINITURA ANTA (per maggiorazioni vedi capitolo PERSONALIZZAZIONI).
PENSILI ABBINABILI CON FONDO GOLA.

22 mm thick 3-side edged door and one side with 30° shape and integrated handle.
Doors and drawers made by double-face melamine panels; matching ABS edge on 3 sides.
Doors and drawers made by chipboard panels with external face in silk effect PET foil and internal face in matching melamine; matching abs edge on 3 sides.
Doors and drawers made by chipboard panels with double-face fenix foil; matching abs edge on 3 sides.
Doors and drawers made by postformed mdf lacquered panels in matt or glossy finish; internal face in matching matt finish.

OPTIONAL MATCHING COLOUR SIDE PANELS ARE AVAILABLE (for extra charge see CUSTOMIZATION chapter).
WALL UNITS AVAILABLE WITH GROOVE BOTTOM ONLY

Misure ante | Door measures

Misure disponibili per ante (basi, pensili e colonne)
Available measures for doors (base and wall and tall units)

	H 117	H 147	H 177	H 237	H 357	H 417	H 477	H 597	H 717	H 777	H 957	H 1197	H 1317	H 1377	H 1557	H 2037	H 2097	H 2277	H 2337
L 147																			
L 297																			
L 397																			
L 447																			
L 597																			
L 747																			
L 897																			
L 1197																			
L 1497																			
L 1797																			

Misure disponibili Available measures

Sovrapprezzo | Surcharges

Maniglia TREND LINEA

TREND LINEA handle	L. W.	Orizzontale Horizontal	Sovrapprezzo Surcharges
A 	da 15 a 60 cm		+ 15
	da 75 a 120 cm		+ 23

Contromaniglia TREND LINEA

Da utilizzare nell'anta superiore delle colonne
TREND LINEA reverse handle
To be used on tall unit upper doors

B 	da 15 a 60 cm		+ 15
	da 75 a 120 cm		+ 23

Finiture disponibili Finishes

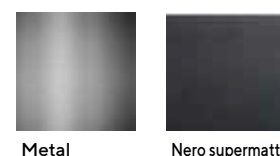

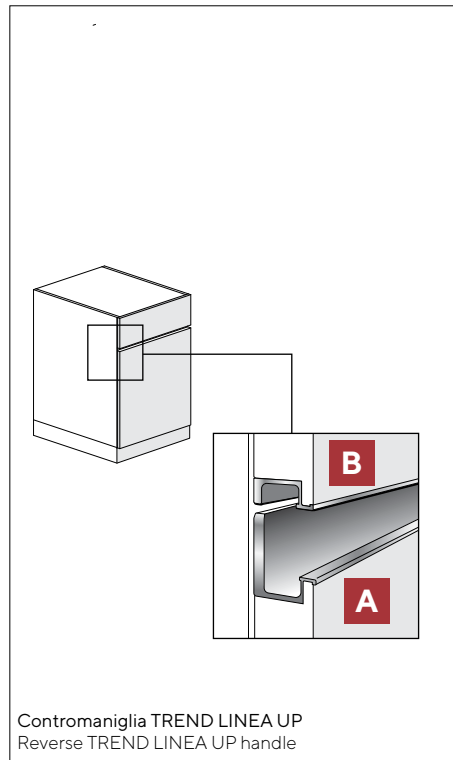
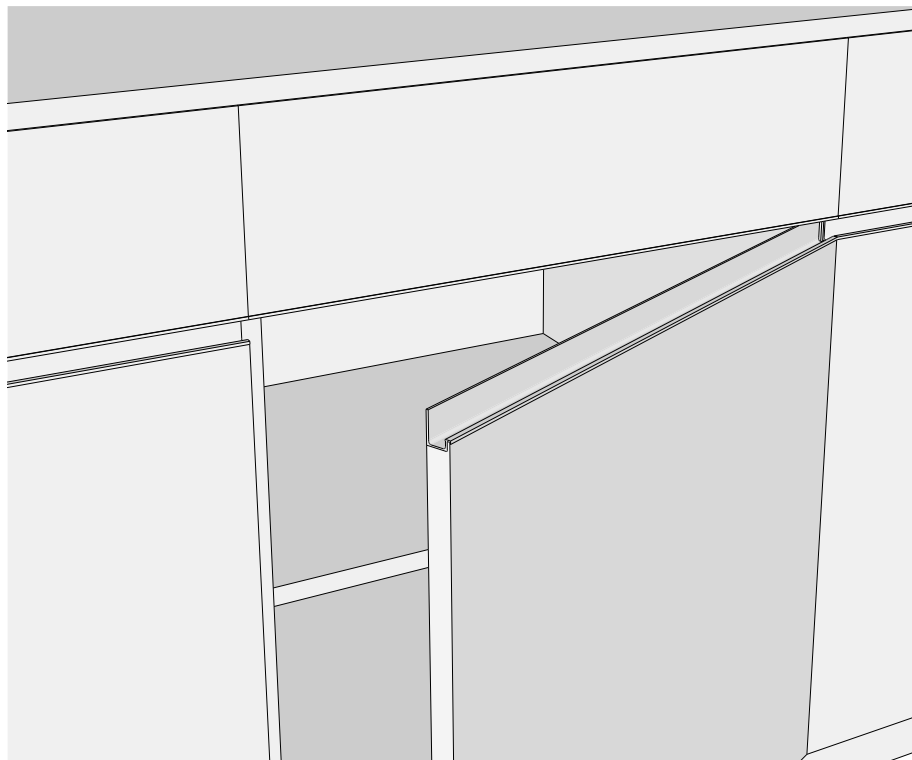

Sezione ante
Door section



Anta di spessore 22 mm bordata 3 lati e 1 lato con maniglia integrata.
 Frontali in nobilitato bifacciale con bordo abs in tinta sui 3 lati.
 Frontali in mdf rivestito lato esterno in PET effetto seta e lato interno melaminico in tinta con bordo in abs in tinta sui 3 lati.
 Frontali in mdf rivestito due lati in fenix con bordo in abs in tinta sui 3 lati.
 Frontali in mdf postformato con fondo poliesterato e laccato in finitura opaca o lucida. Interno in tinta sempre laccato opaco.

FIANCHI PERSONALIZZATI IN FINITURA ANTA (per maggiorazioni vedi capitolo PERSONALIZZAZIONI).
 PENSILI ABBINABILI CON FONDO GOLA.

22 mm thick 3-side edged door and one side with 30° shape and integrated handle.
 Doors and drawers made by double-face melamine panels; matching ABS edge on 3 sides.
 Doors and drawers made by chipboard panels with external face in silk effect PET foil and internal face in matching melamine; matching abs edge on 3 sides.
 Doors and drawers made by chipboard panels with double-face fenix foil; matching abs edge on 3 sides.
 Doors and drawers made by postformed mdf lacquered panels in matt or glossy finish; internal face in matching matt finish.

OPTIONAL MATCHING COLOUR SIDE PANELS ARE AVAILABLE (for extra charge see CUSTOMIZATION chapter).
 WALL UNITS AVAILABLE WITH GROOVE BOTTOM ONLY

Misure ante | Door measures

Misure disponibili per ante (basi, pensili e colonne)
 Available measures for doors (base and wall and tall units)

	H 117	H 177	H 237	H 357	H 477	H 597	H 717	H 777	H 957	H 1197	H 1317	H 1557	H 2037	H 2277
L 147														
L 297														
L 397														
L 447														
L 597														
L 747														
L 897														
L 1197														
L 1497														
L 1797														

■ Misure disponibili Available measures

Sovrapprezzo | Surcharges

Maniglia TREND LINEA

TREND LINEA handle	L. W.	Orizzontale Horizontal	Sovrapprezzo Surcharges
A 	da 15 a 60 cm		+ 15
	da 75 a 120 cm		+ 23

Contromaniglia TREND LINEA

Da utilizzare nell'anta superiore delle colonne
 TREND LINEA reverse handle
 To be used on tall unit upper doors

B 	da 15 a 60 cm		+ 15
	da 75 a 120 cm		+ 23

Finiture disponibili Finishes

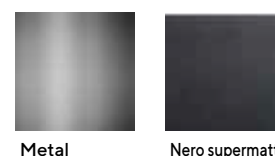

Metal

Nero supermatt

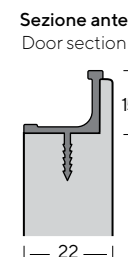
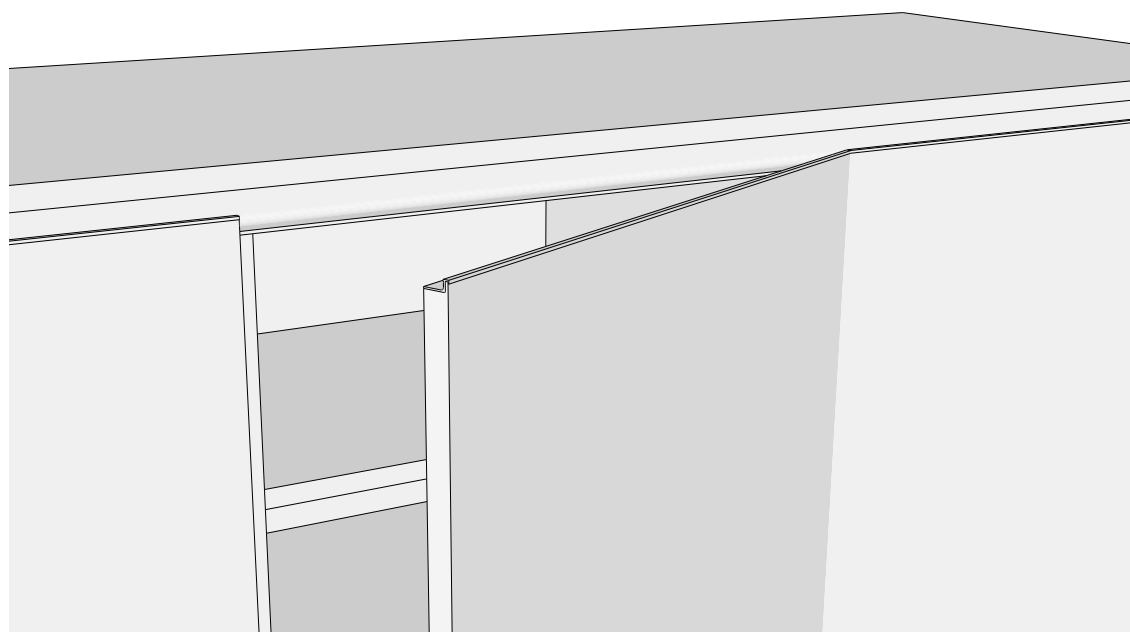

Anta di spessore 22 mm bordata 3 lati e 1 lato con maniglia integrata.
 Frontali in nobilitato bifacciale con bordo abs in tinta sui 3 lati.
 Frontali in mdf rivestito lato esterno in PET effetto seta e lato interno melaminico in tinta con bordo in abs in tinta sui 3 lati.
 Frontali in mdf rivestito due lati in fenix con bordo in abs in tinta sui 3 lati.
 Frontali in mdf postformato con fondo poliesterato e laccato in finitura opaca o lucida. Interno in tinta sempre laccato opaco.

FIANCHI PERSONALIZZATI IN FINITURA ANTA (per maggiorazioni vedi capitolo PERSONALIZZAZIONI).
 FIANCHI A C TERMINALI CON GOLA (vedi pag. 104)
 PENSILI ABBINABILI CON FONDO GOLA.

22 mm thick 3-side edged door and one side with integrated handle.
 Doors and drawers made by double-face melamine panels; matching ABS edge on 3 sides.
 Doors and drawers made by chipboard panels with external face in silk effect PET foil and internal face in matching melamine; matching abs edge on 3 sides.
 Doors and drawers made by chipboard panels with double-face fenix foil; matching abs edge on 3 sides.
 Doors and drawers made by postformed mdf lacquered panels in matt or glossy finish; internal face in matching matt finish.

OPTIONAL MATCHING COLOUR SIDE PANELS ARE AVAILABLE (for extra charge see CUSTOMIZATION chapter).
 GROOVE AND "C" SIDE PANEL (see pag. 104)
 WALL UNITS AVAILABLE WITH GROOVE BOTTOM ONLY.

Misure ante | Door measures

Misure disponibili per ante (basi, pensili e colonne)
 Available measures for doors (base and wall and tall units)

	H 117	H 147	H 177	H 237	H 327	H 357	H 417	H 477	H 597	H 717	H 777	H 957	H 1197	H 1317	H 1377	H 1557	H 2097	H 2337
L 147																		
L 297																		
L 397																		
L 447																		
L 597																		
L 747																		
L 897																		
L 1197																		
L 1497																		
L 1797																		

Misure disponibili Available measures

Sovrapprezzo | Surcharges

Maniglia TREND GRIP
 TREND GRIP handle



L. W.	Orizzontale Horizontal	Sovrapprezzo Surcharges
da 15 a 60 cm		+ 15
da 75 a 120 cm		+ 23

H. H.	Verticale Vertical	Sovrapprezzo Surcharges
da 24 a 72 cm		+ 15
da 78 a 132 cm		+ 23
da 138 a 234 cm		+ 30

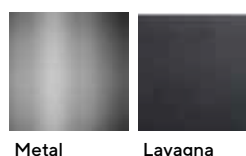

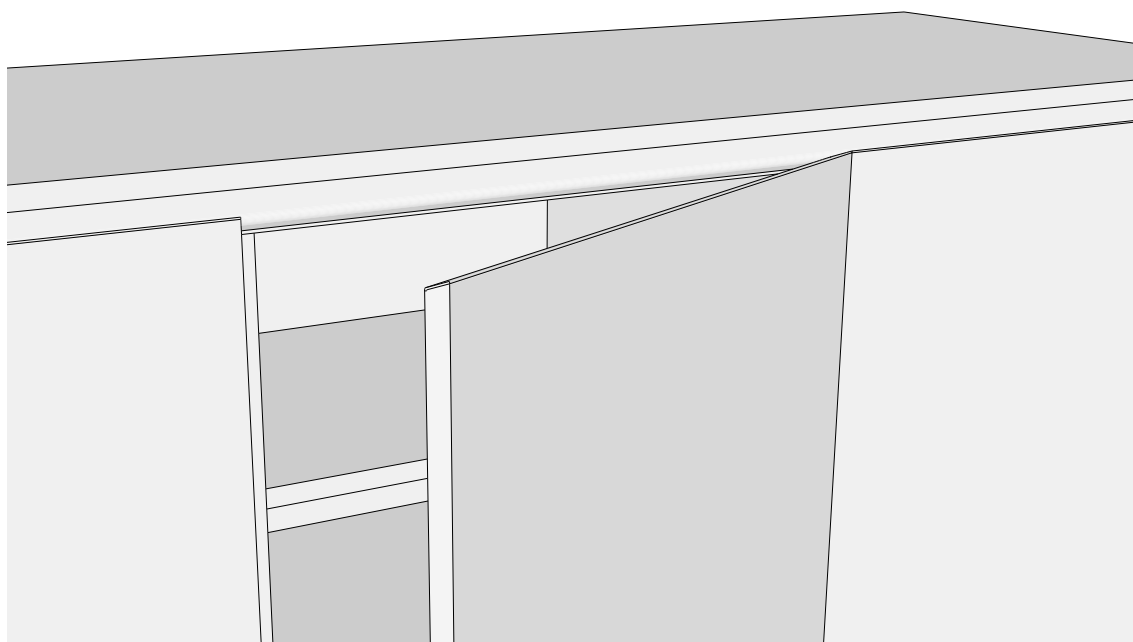

Sezione ante
Door section

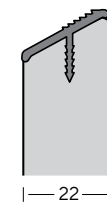

Anta di spessore 22 mm bordata 3 lati e 1 lato con profilo a 30° e maniglia integrata.
 Frontali in nobilitato bifacciale con bordo abs in tinta sui 3 lati.
 Frontali in mdf rivestito lato esterno in PET effetto seta e lato interno melaminico in tinta con bordo in abs in tinta sui 3 lati.
 Frontali in mdf rivestito due lati in fenix con bordo in abs in tinta sui 3 lati.
 Frontali in mdf postformato con fondo poliesterato e laccato in finitura opaca o lucida. Interno in tinta sempre laccato opaco.

FIANCHI PERSONALIZZATI IN FINITURA ANTA (per maggiorazioni vedi capitolo PERSONALIZZAZIONI).
 PENSILI ABBINABILI CON FONDO GOLA.

22 mm thick 3-side edged door and one side with 30° shape and integrated handle.
 Doors and drawers made by double-face melamine panels; matching ABS edge on 3 sides.
 Doors and drawers made by chipboard panels with external face in silk effect PET foil and internal face in matching melamine; matching abs edge on 3 sides.
 Doors and drawers made by chipboard panels with double-face fenix foil; matching abs edge on 3 sides.
 Doors and drawers made by postformed mdf lacquered panels in matt or glossy finish; internal face in matching matt finish.

OPTIONAL MATCHING COLOUR SIDE PANELS ARE AVAILABLE (for extra charge see CUSTOMIZATION chapter).
 WALL UNITS AVAILABLE WITH GROOVE BOTTOM ONLY

Misure ante | Door measures

Misure disponibili per ante (basi, pensili e colonne)
 Available measures for doors (base and wall and tall units)

	H 117	H 147	H 177	H 237	H 327	H 357	H 417	H 477	H 597	H 717	H 777	H 957	H 1197	H 1317	H 1377	H 1557	H 2097	H 2337
L 147																		
L 297																		
L 397																		
L 447																		
L 597																		
L 747																		
L 897																		
L 1197																		
L 1497																		
L 1797																		

Misure disponibili Available measures

Sovrapprezzo | Surcharges

Maniglia TREND 30°
 TREND 30° handle

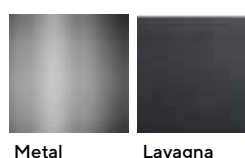

L. Vv.	Orizzontale Horizontal	Sovrapprezzo Surcharges
da 15 a 60 cm		+ 15
da 75 a 120 cm		+ 23
H. H.	Verticale Vertical	Sovrapprezzo Surcharges
da 24 a 72 cm		+ 15
da 78 a 132 cm		+ 23
da 138 a 234 cm		+ 30

3 Fascia | Group

Seta
Silk

B Categoria fianco finitura anta
Frame finishing side category

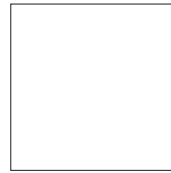

Talco seta

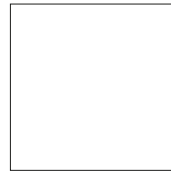

Polvere seta



Mandorla seta *

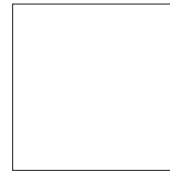

Castano seta

* disponibile da ottobre 2026

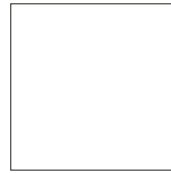

Zinco seta

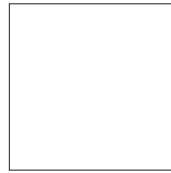

Perla seta



Torba seta

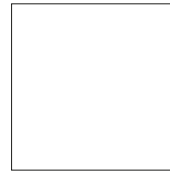

Nero seta

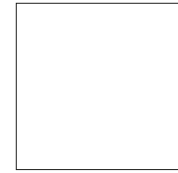

Verde petrolio seta

Nobilitato micalizzato
Melamine - Ribbed

C Categoria fianco finitura anta
Frame finishing side category



Micalizzato cipria

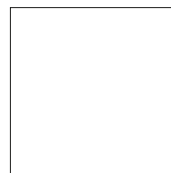

Micalizzato greige

Nobilitato calce
Melamine Both faced

C Categoria fianco finitura anta
Frame finishing side category

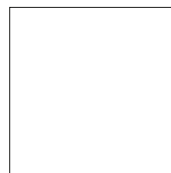

Calce sabbia

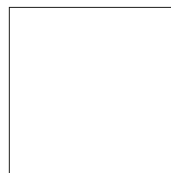

Calce ecrù



Calce ombra

Nobilitato resina
Melamine Both faced

C Categoria fianco finitura anta
Frame finishing side category

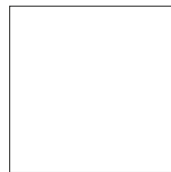

Resina nuvola

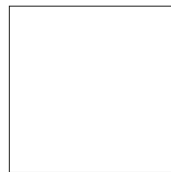

Resina tortora

Nobilitato legno
Melamine Both faced

C Categoria fianco finitura anta
Frame finishing side category

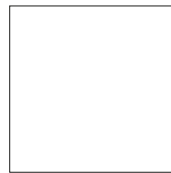

Rovere platino

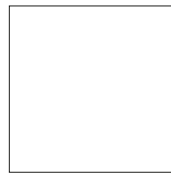

Rovere arizona



Noce iberico



Noce amazzonia



Rovere black

Nobilitato legno segno
Melamine Both faced

C Categoria fianco finitura anta
Frame finishing side category

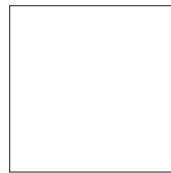

Segno iberico

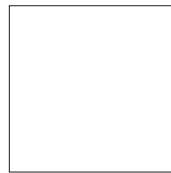

Segno amazzonia

5 Fascia | Group

Fenix Fenix

I Categoria fianco finitura anta
Frame finishing side category



Bianco kos Beige arizona Castoro ottawa Grigio Londra Grigio bromo Nero ingo

Laccato opaco Bifacciale Matt lacquered Both faced

D Categoria fianco finitura anta
Frame finishing side category

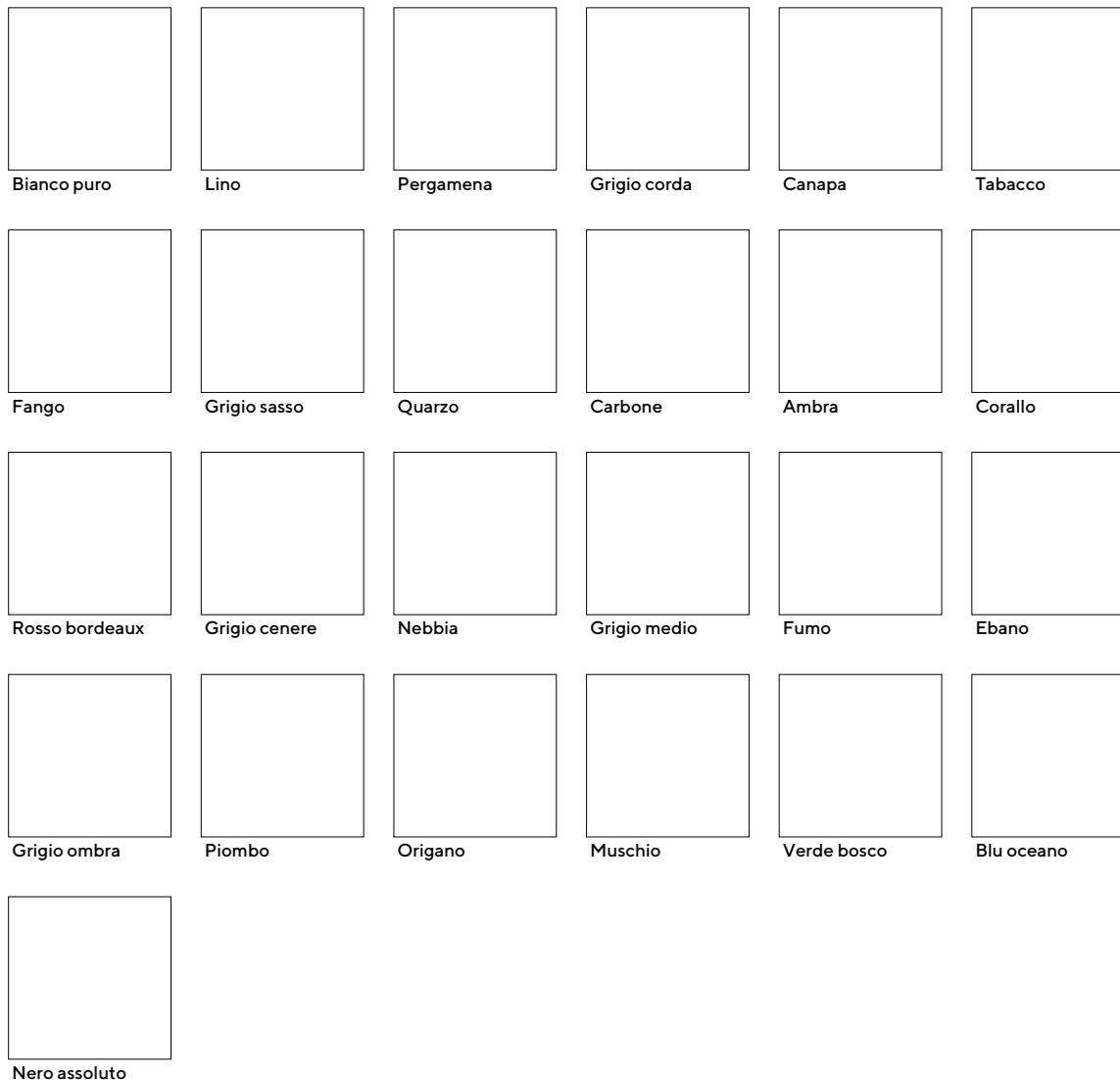

Bianco puro Lino Pergamena Grigio corda Canapa Tabacco
Fango Grigio sasso Quarzo Carbone Ambra Corallo
Rosso bordeaux Grigio cenere Nebbia Grigio medio Fumo Ebano
Grigio ombra Piombo Origano Muschio Verde bosco Blu oceano
Nero assoluto

Laccato lucido interno in tinta opaco Glossy lacquered inner face in matt matching color

F Categoria fianco finitura anta
Frame finishing side category



Bianco puro lucido

NCS-RAL opaco/lucido
Matt/glossy NCS-RAL



NCS-RAL*

* Disponibile con maggiorazione.
Vedere retrocopertina.

* Available with surcharge.
See back cover.

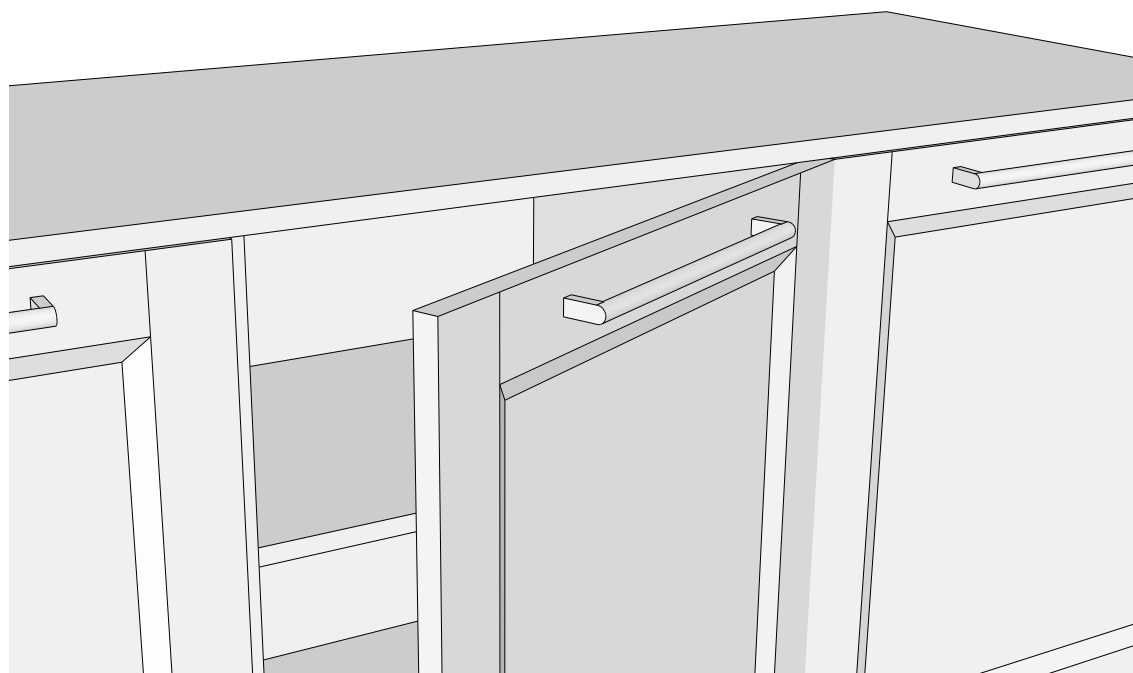

Sezione ante
Door section

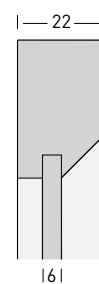

Anta a telaio di spessore 22 mm.

Frontali in mdf (anta a telaio in 5 pezzi con pannello in mdf spessore 6 mm) rivestito in alkorcell laccato in finitura opaca "Zero gloss".

Frontali vetrina in mdf (anta a telaio in 5 pezzi con pannello in vetro spessore 4 mm in finitura satinata) rivestito in alkorcell laccato in finitura opaca "Zero gloss".

FIANCHI PERSONALIZZATI IN FINITURA ANTA (per maggiorazioni vedi capitolo PERSONALIZZAZIONI).

PENSILI ABBINABILI CON MANIGLIA O CON FONDO GOLA.

I FRONTALI NON SONO RIDUCIBILI A MISURA.

22 mm thick frame door.

Doors and drawers made by mdf (5-piece frame door with 6 mm thick panel) covered with alkorcell lacquered in matt finish "Zero gloss".

Doors and drawers made by mdf (5-piece frame door with 4 mm thick glass) covered with alkorcell lacquered in matt finish "Zero gloss".

OPTIONAL MATCHING COLOUR SIDE PANELS ARE AVAILABLE (for extra charge see CUSTOMIZATION chapter).

WALL UNITS AVAILABLE WITH HANDLE OR GROOVE BOTTOM.

DOORS AND DRAWERS ARE NOT AVAILABLE ON CUSTOM SIZE.

Misure ante | Door measures

Misure disponibili per ante (basi e pensili e colonne)

Available measures for doors (base and wall and tall units)

	H 117	H 177	H 237	H 357	H 477	H 597	H 717	H 957	H 1317
L 147									
L 297									
L 397									
L 447									
L 597									
L 747									
L 897									
L 1197									

Misure disponibili per ante telaio vetro inglesina

Available measures for inglesina glass frame doors

	* H 357	H 477	H 597	H 717	H 957	H 1317
L 447						
L 597						
L 897						

* **H.36: anta vetro senza inglesina**
H.36: glass door without english style

 Misure disponibili Available measures

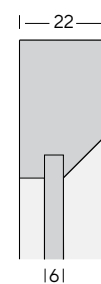
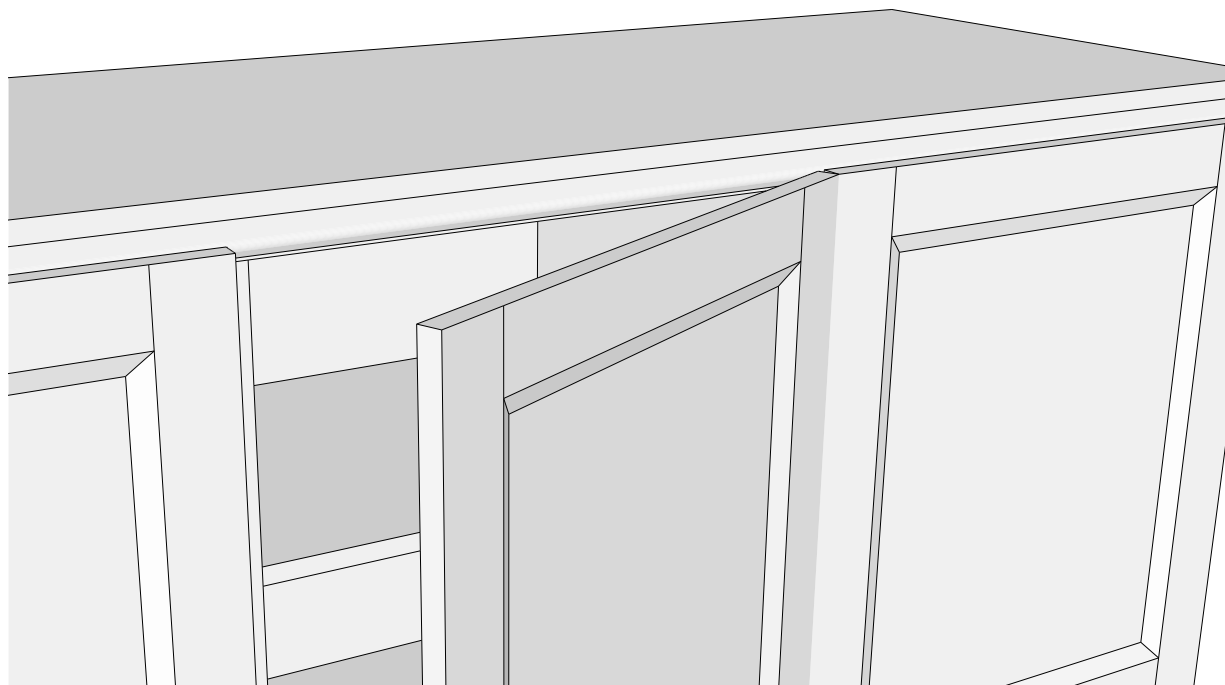

Sezione ante
Door section

Anta a telaio di spessore 22 mm.

Frontali in mdf (anta a telaio in 5 pezzi con pannello in mdf spessore 6 mm) rivestito in alkorcell laccato in finitura opaca "Zero gloss".

Frontali vetrina in mdf (anta a telaio in 5 pezzi con pannello in vetro spessore 4 mm in finitura satinata) rivestito in alkorcell laccato in finitura opaca "Zero gloss".

FIANCHI PERSONALIZZATI IN FINITURA ANTA (per maggiorazioni vedi capitolo PERSONALIZZAZIONI).

PENSILI ABBINABILI CON FONDO GOLA.

I FRONTALI NON SONO RIDUCIBILI A MISURA.

22 mm thick frame door.

Doors and drawers made by mdf (5-piece frame door with 6 mm thick panel) covered with alkorcell lacquered in matt finish "Zero gloss".

Doors and drawers made by mdf (5-piece frame door with 4 mm thick glass) covered with alkorcell lacquered in matt finish "Zero gloss".

OPTIONAL MATCHING COLOUR SIDE PANELS ARE AVAILABLE (for extra charge see CUSTOMIZATION chapter).

WALL UNITS AVAILABLE WITH HANDLE OR GROOVE BOTTOM.

DOORS AND DRAWERS ARE NOT AVAILABLE ON CUSTOM SIZE.

Misure ante | Door measures

Misure disponibili per ante (basi, pensili e colonne)

Available measures for doors (base and wall and tall units)

	H 117	H 147	H 177	H 237	H 327	H 357	H 477	H 597	H 717	H 957	H 1317
L 147											
L 297											
L 397											
L 447											
L 597											
L 747											
L 897											
L 1197											

Misure disponibili per ante telaio vetro inglesina

Available measures for inglesina glass frame doors

	* H 357	H 477	H 597	H 717	H 957	H 1317
L 447						
L 597						
L 897						

* **H.36: anta vetro senza inglesina**
H.36: glass door without english style

■ Misure disponibili Available measures

3 Fascia | Group







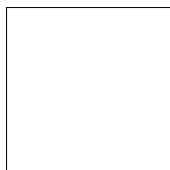
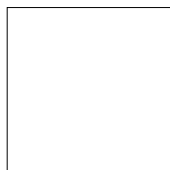
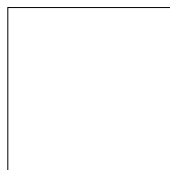
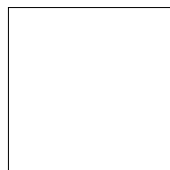

Materico laccato "Zero Gloss"
Lacquered materico "Zero Gloss"

F Categoria fianco finitura anta
Frame finishing side category

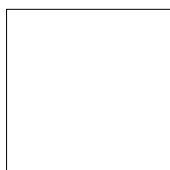
					
Bianco puro	Lino	Grigio corda	Canapa	Tabacco	Grigio sasso
					
Ambra	Corallo	Rosso bordeaux	Nebbia	Grigio medio	Origano
					
Verde bosco	Blu oceano				

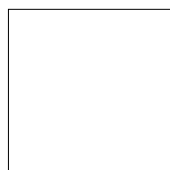
Finitura anta - Vetro stopsol
Frame finished - Stopsol glass



					
Bianco puro	Lino	Grigio corda	Canapa	Tabacco	Grigio sasso
					
Ambra	Corallo	Rosso bordeaux	Nebbia	Grigio medio	Origano
					
Verde bosco	Blu oceano				

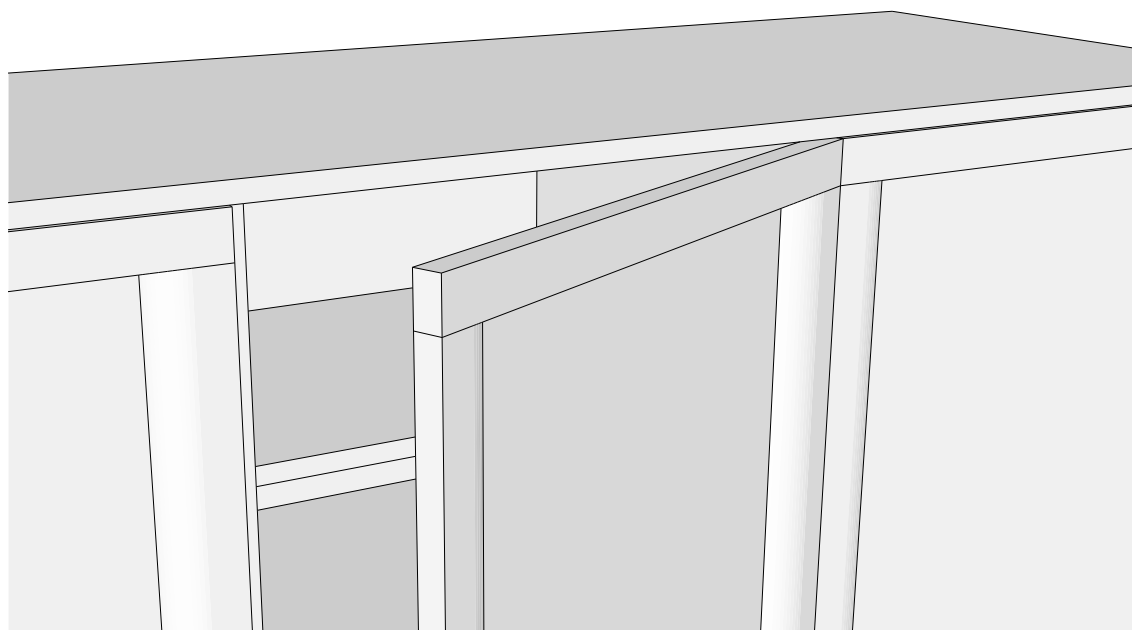

Sezione ante
Door section

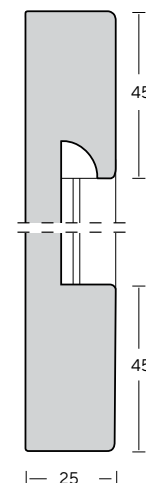

Anta a telaio di spessore 25 mm.

Frontali in mdf laccato opaco (anta a telaio in pezzo unico) con incavo per apertura inferiore o superiore.

FIANCHI PERSONALIZZATI IN FINITURA ANTA (per maggiorazioni vedi capitolo PERSONALIZZAZIONI).

PENSILI ABBINABILI CON FONDO GOLA.

I FRONTALI NON SONO RIDUCIBILI A MISURA.

25 mm thick frame door.

Doors and drawers made by matt lacquered mdf (1-piece frame door) with lower or upper groove for opening.

OPTIONAL MATCHING COLOUR SIDE PANELS ARE AVAILABLE (for extra charge see CUSTOMIZATION chapter).

WALL UNITS AVAILABLE WITH GROOVE BOTTOM.

DOORS AND DRAWERS ARE NOT AVAILABLE ON CUSTOM SIZE

Misure ante | Door measures

Misure disponibili per ante (basi, pensili e colonne)

Available measures for doors (base and wall and tall units)

	H 177	H 237	H 357	H 417	H 477	H 597	H 717	H 777	H 957	H 1317	H 1377	H 1557
L 146												
L 296												
L 396												
L 446												
L 596												
L 746												
L 896												
L 1196												
L 1496												

■ Misure disponibili Available measures

8 Fascia | Group

Bellaria
Laccato opaco
Matt lacquered

D Categoria fianco finitura anta
Frame finishing side category



NCS-RAL opaco
Matt NCS-RAL



NCS-RAL*

* Disponibile con maggiorazione.
Vedere retrocopertina.

* Available with surcharge.
See back cover.

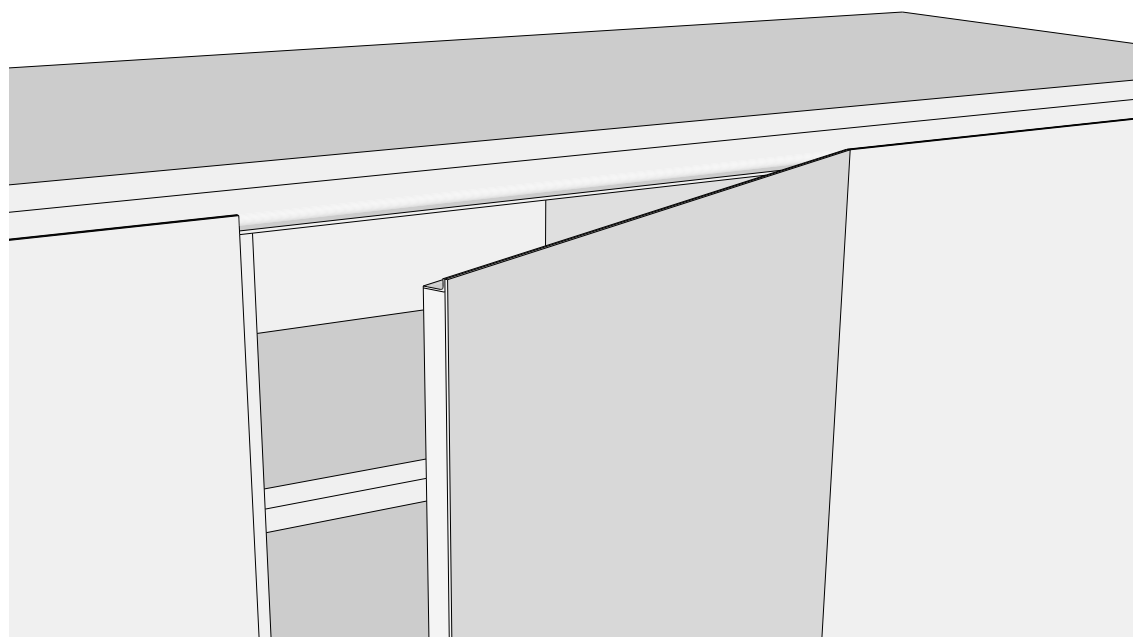

Sezione ante
Door section

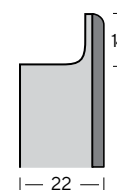

Anta a telaio di spessore 22 mm.

Telaio in alluminio (anta a telaio in 4 pezzi con vetro applicato di spessore 4 mm) con vetro retrolaccato opaco o lucido e con pannello interno di protezione disponibile nella stessa finitura del telaio.

FIANCHI PERSONALIZZATI LACCATI IN TINTA ANTA (per maggiorazioni vedi capitolo PERSONALIZZAZIONI).

FIANCHI A C TERMINALI CON GOLA (vedi pag. 106)

PENSILI ABBINABILI CON FONDO GOLA.

22 mm thick frame door.

Aluminium frame door (4-piece frame door with 4 mm thick applied glass) with glass in matt or glossy lacquered finish.

GROOVE AND "C" SIDE PANEL (see pag. 106)

OPTIONAL MATCHING COLOUR SIDE PANELS ARE AVAILABLE (for extra charge see CUSTOMIZATION chapter).

WALL UNITS AVAILABLE WITH GROOVE BOTTOM.

Misure ante | Door measures

Misure disponibili per ante (basi, pensili e colonne)

Available measures for doors (base and wall and tall units)

	H147	H177	H237	H327	H357	H417	H477	H597	H717	H777	H957	H1197	H1317	H1377	H1557	H2097	H2337
L147																	
L297																	
L397																	
L447																	
L597																	
L747																	
L897																	
L1197																	
L1497																	
L1797																	

■ Misure disponibili Available measures

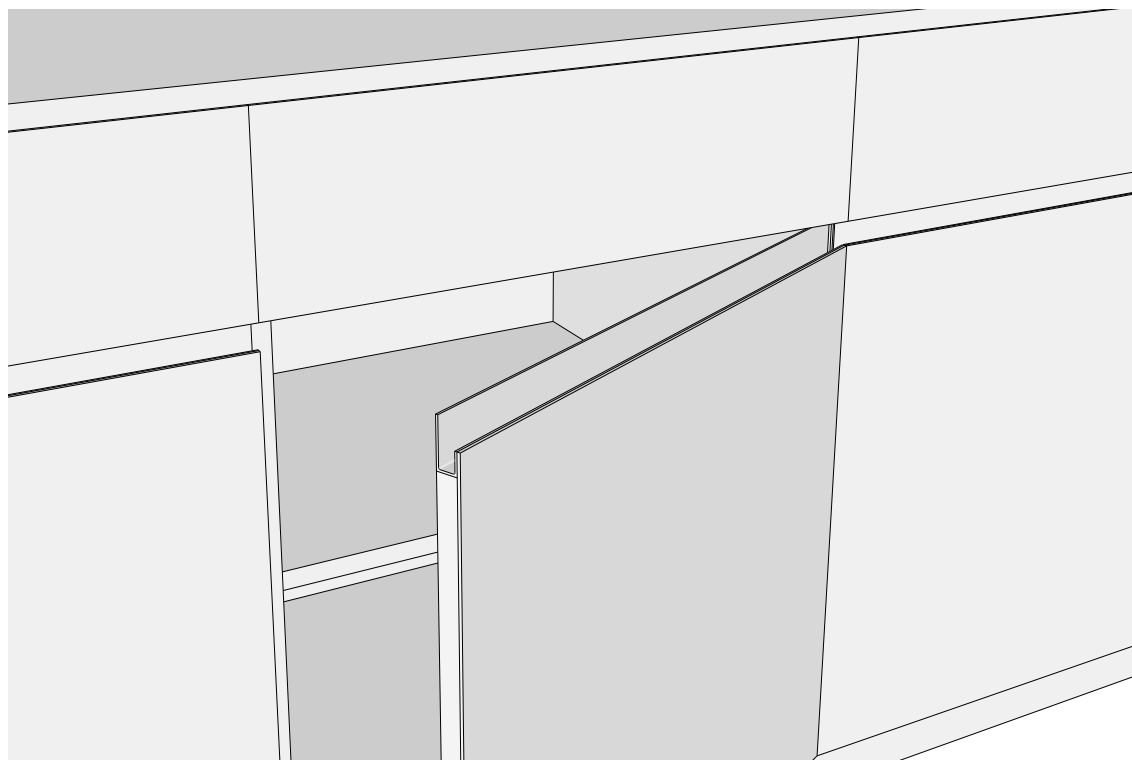

Sezione frontale superiore
Upper door section

| — 22 — |

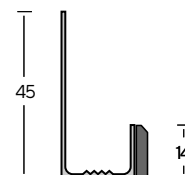
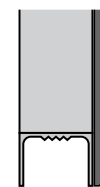

| — 22 — |

Sezione frontale inferiore
Lower door section

Anta a telaio di spessore 22 mm.

Telaio in alluminio (anta a telaio in 4 pezzi con vetro applicato di spessore 4 mm) con vetro retrolaccato opaco o lucido e con pannello interno di protezione disponibile nella stessa finitura del telaio.

FIANCHI PERSONALIZZATI LACCATI IN TINTA ANTA (per maggiorazioni vedi capitolo PERSONALIZZAZIONI).

FIANCHI A C TERMINALI CON GOLA (vedi pag. 106)

PENSILI ABBINABILI CON FONDO GOLA.

22 mm thick frame door.

Aluminium frame door (4-piece frame door with 4 mm thick applied glass) with glass in matt or glossy lacquered finish.

GROOVE AND "C" SIDE PANEL (see pag. 106)

OPTIONAL MATCHING COLOUR SIDE PANELS ARE AVAILABLE (for extra charge see CUSTOMIZATION chapter).

WALL UNITS AVAILABLE WITH GROOVE BOTTOM.

Misure ante | Door measures

Misure disponibili per ante (basi e pensili e colonne)

Available measures for doors (base and wall and tall units)

	H147	H177	H237	H327	H357	H417	H477	H597	H717	H777	H957	H1197	H1317	H1377	H1557	H2097	H2337
L147																	
L297																	
L397																	
L447																	
L597																	
L747																	
L897																	
L1197																	
L1497																	
L1797																	

Misure disponibili Available measures

Finiture telaio
Frame finishes



Titanio



Nero

9 Fascia | Group

Vetro lucido
Glossy glass

F Categoria fianco finitura anta
Frame finishing side category

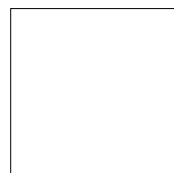

Bianco puro

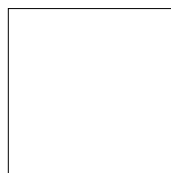

Grigio cenere



Canapa

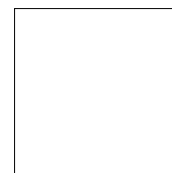

Grigio sasso

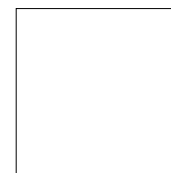

Argilla 177



Grigio ombra

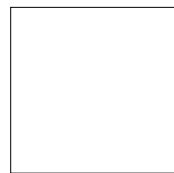

Rosso bordeaux

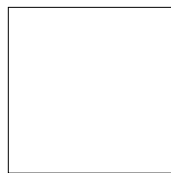

Blu oceano

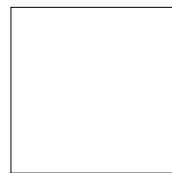

Nero assoluto

10 Fascia | Group

Vetro opaco
Matt glass

D Categoria fianco finitura anta
Frame finishing side category

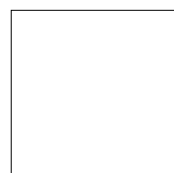

Bianco puro



Grigio cenere



Canapa

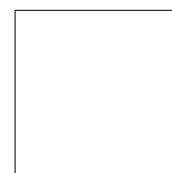

Grigio sasso

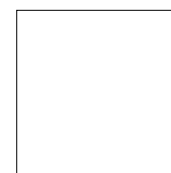

Argilla 177



Grigio ombra

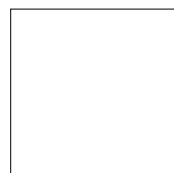

Ambra

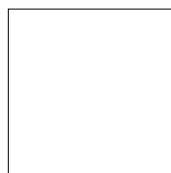

Corallo



Rosso bordeaux



Blu oceano

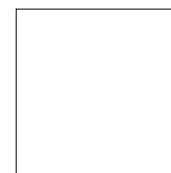

Nero assoluto

Vetro opaco mineral
Mineral matt glass

D Categoria fianco finitura anta
Frame finishing side category



Mineral silver

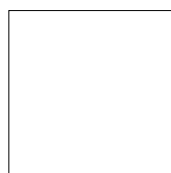

Mineral bronze

Finiture telaio
Frame finishes



Titanio



Nero

11 Fascia | Group

Vetro opaco rail
Matt glass

D Categoria fianco finitura anta
Frame finishing side category

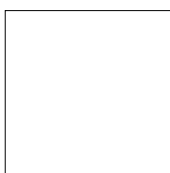

Bianco puro

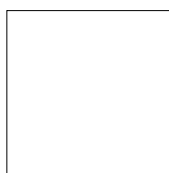

Grigio cenere

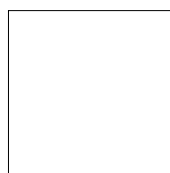

Canapa



Grigio ombra



Corallo

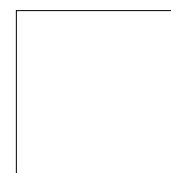

Blu oceano

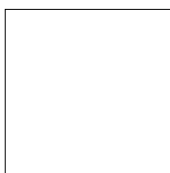

Nero assoluto