

lumen

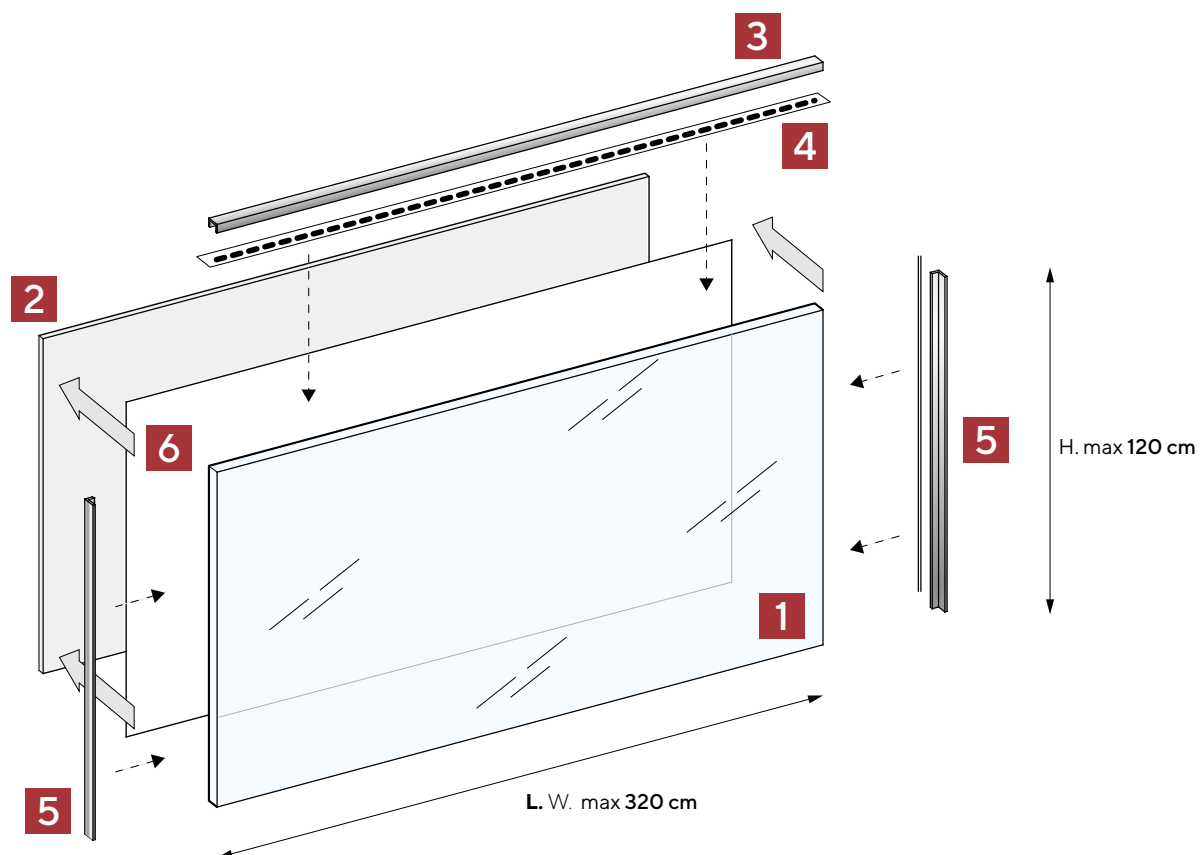

- 1** Lastra vetro temperato 8 mm
8 mm tempered glass plate
- 2** Lastra Magnetolab
Magnetolab plate
- 3** Profilo alluminio alloggiamento (e dissipatore) strisce Led HL
Profile containment and sink LED strip HL
- 4** Strip LED HL (cavo L.5 m. con uscita a sinistra)
Strip LED HL (5 m. long cable with left socket)
- 5** Profilo alluminio protezione laterale
Aluminion profile side protection
- 6** Trattamenti chimici e meccanici
Chemical and mechanical treatments

Finiture | Finishing

Vetro Glass



Bianco lucido

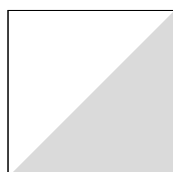

Bianco acidato

Accessori Accessories

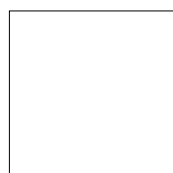

Bianco

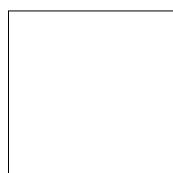

Piombo



Titanio

lumen



ATTENZIONE!
Non appoggiare nulla
sopra al profilo led.

**MANCA TRADUZIONE
INGLESE QUI**

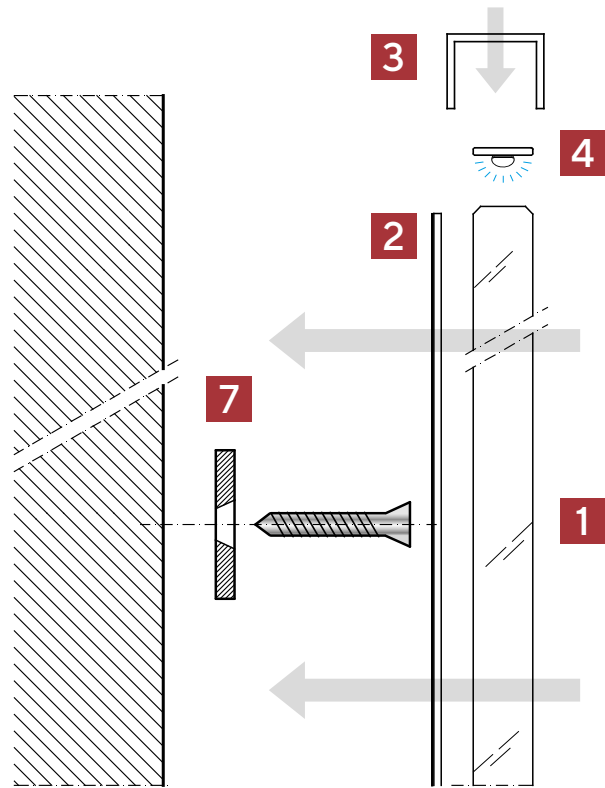
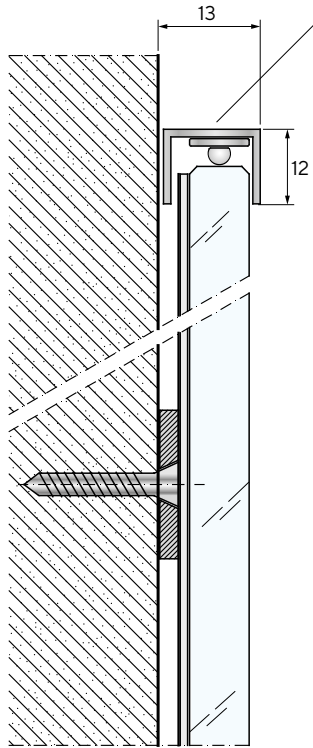

Il pannello LUMEN viene sempre fornito di 3 profili di chiusura.
LUMEN is been always supplied complete with finishing profile on three sides.

Per l'accensione prevedere un interruttore in ambiente,
altrimenti impiegare il telecomando (non compreso nel prezzo).
To turn on the panel install a switch in the room,
otherwise use the remote control.

Fino a 60 cm prezzo al metro lineare.
Da 61 a 120 cm prezzo al metro quadrato.
Until cm 60 prize per linear meter.
From 61 to 120 cm prize per square meter.

- 1** Lastra vetro temperato 8 mm
8 mm tempered glass plate
- 2** Lastra Magnetolab
Magnetolab plate
- 3** Profilo alluminio alloggiamento (e dissipatore) strisce Led HL
Profile containment and sink LED strip HL
- 4** Strip LED HL (cavo L.5 m. con uscita a sinistra)
Strip LED HL (5 m. long cable with left socket)
- 7** Rondella Magnete per fissaggio a parete
Washer magnet for wall mounting

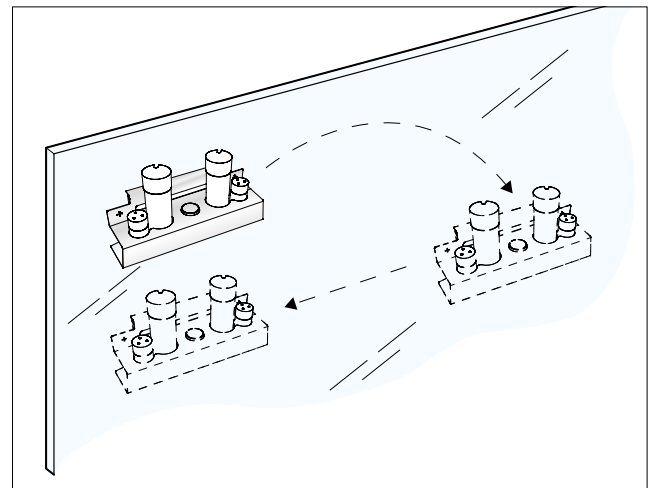
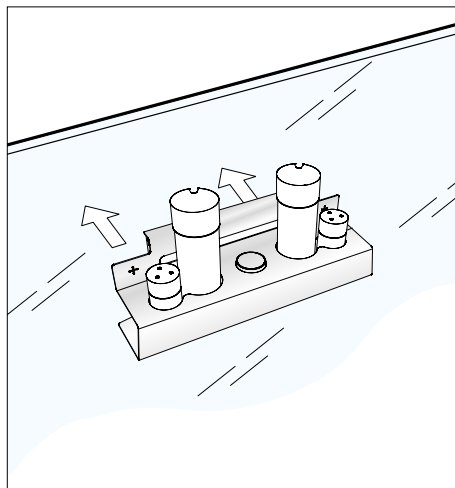
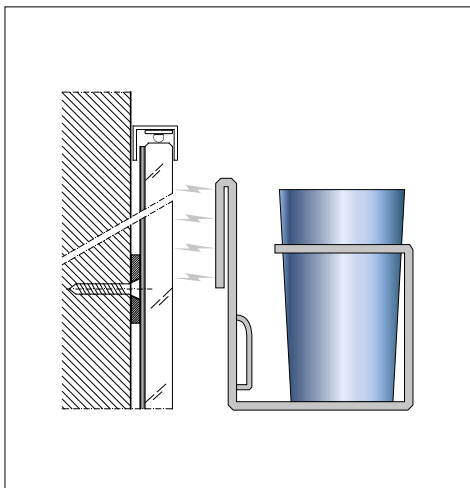

Gli accessori sono realizzati con materiale magnetico,
e sono liberamente posizionabili.
Accessories magnetic so they can be freely placed
en the glass surface.

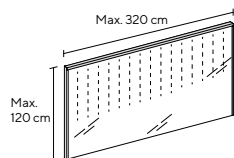

Schienale Magnetico in vetro

Altezza sino a 60 cm. Lunghezza max 320 cm.

Retroverniato bianco.
Illuminazione a LED, (trasformatore incluso)
con profili su tre lati.
Spessore 8 mm.

Magnetic glass panel

Height until 60 cm. Max. length 320 cm.

White painted back.
LED lights, (power supply included)
with frame on three sides.
Thickness 8 mm.

Altezza sino a 60 cm. Lunghezza max 320 cm.

Height until 60 cm. Max. length 320 cm.

	Codice Code	Prezzo Price
Al metro lineare Linear meter	TSL313060M01	-

Altezza da 61 a 120 cm. Lunghezza max 320 cm.

Height from 61 to 120 cm. Max. length 320 cm.

	Codice Code	Prezzo Price
Al metro lineare Linear meter	TSL313060M01	-

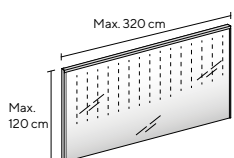

Schienale Magnetico in vetro

Retroverniato bianco, acidato lato vista.
Illuminazione a LED, (trasformatore incluso)
con profili su tre lati.
Spessore 8 mm.

Magnetic glass panel

White painted back, acidato side view.
LED lights, (power supply included)
with frame on three sides.
Thickness 8 mm.

Altezza sino a 60 cm. Lunghezza max 320 cm.

Height until 60 cm. Max. length 320 cm.

	Codice Code	Prezzo Price
Al metro lineare Linear meter	TSL413060M01	-

Altezza da 61 a 120 cm. Lunghezza max 320 cm.

Height from 61 to 120 cm. Max. length 320 cm.

	Codice Code	Prezzo Price
Al metro quadro Square meter	TSL413120M02	-

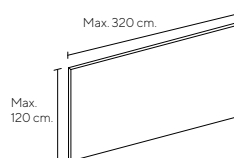

Schienale Magnetico in vetro senza illuminazione a LED

Retroverniato bianco.
Completo di profilo metallico sui 3 lati. Spessore 8 mm.

Magnetic glass panel without LED light system

Back-painted in white colour.
Metal profile on 3 sides. 8 mm thick.

Altezza sino a 60 cm. Lunghezza max 320 cm.

Height until 60 cm. Max. length 320 cm.

	Codice Code	Prezzo Price
Al metro lineare Linear meter	TSL013060M01	-

Altezza sino a 60 cm. Lunghezza max 320 cm.

Height until 60 cm. Max. length 320 cm.

	Codice Code	Prezzo Price
Al metro lineare Linear meter	TSL013120M02	-

Telecomando ON/OFF + ricevitore dimmer

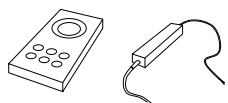

Si possono gestire fino a 4 schienali in serie con un unico telecomando. Ogni schienale necessita di un ricevitore dimmer quindi nel caso di una composizione con 2 schienali è necessario ordinare
1 Telecomando ON/OFF + ricevitore dimmer
1 Ricevitore dimmer aggiuntivo

ON-OFF remote control + dimmer (optional)

Up to 4 backrests can be managed in series with a single remote control.

	Codice Code	Prezzo Price
telecomando + dimmer remote control + dimmer	50L100200M2E	-
dimmer aggiuntivo additional dimmer	50LA03MARICOL	-

Trasformatore elettronico (incluso nel prezzo dello schienale)

In aggiunta al pannello luminoso a LED.
Alimenta fino a 400 cm.

Electronic transformer (included in the panel price)

Additional to the bright LED panel.
Power range up to 400 cm.

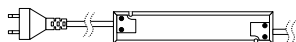

	Codice Code	Prezzo Price
	50L100200M1E	-

Smart moving

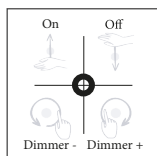

sistema di regolazione della luminosità dello schienale che, grazie a sensori del movimento, gestisce accensione, spegnimento, intensità e temperatura della luce, senza interruttori né telecomandi. Effettuando semplici gesti con le mani, non è necessario toccare lo schienale.

Smart moving gesture controlled switch

	Codice Code	Prezzo Price
Smart moving	50LA003MA03EL	-

HELPHY LIGHT

Helpy light

sistema di illuminazione di sicurezza che, in caso di interruzione di energia elettrica, riattiva la luce dello schienale permettendo di continuare i lavori in cucina, illuminando anche l'ambiente circostante.
Autonomia da 1 a 4 ore a seconda dell'intensità di luce desiderata.

Electronic transformer

	Codice Code	Prezzo Price
Helpy light	50LA003MAHL01	-

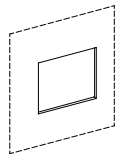

Maggiorazione per foro rettangolare
(oltre alla posizione specificare sempre tipo o
dimensione scatola)

Specificare dimensioni o posizione del foro, distanza minima del perimetro
del pannello 30 mm.

Surcharge for rectangular cut
(besides the position, always specify type and
dimension of the box)

Specify the size and position of the cut, minimum distance from the panel
perimeter 30 mm

Codice
Code

Prezzo
Price

50L000000M1S

-

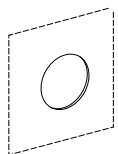

Maggiorazione per foro rotondo

Specificare dimensioni o posizione del foro, distanza minima del perimetro
del pannello 30 mm.

Surcharge for cut round

Specify the size and position of the cut, minimum distance from the panel
perimeter 30 mm

Codice
Code

Prezzo
Price

50L000000M2S

-

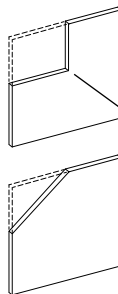

Maggiorazione per scanso
(oltre alla posizione specificare sempre dimensioni)
Gli angoli di taglio avranno una raggatura minima di 10 mm

Raggio minimo 10 mm

Surcharge for outside cut (besides the position, always
specify dimension)
The cut angles will have at least a 10 mm radius

Codice
Code

Prezzo
Price

50L000000M3S

-

Accessori LUMEN Accessories LUMEN

Mensola 3A01

Portata massima: 2 kg.

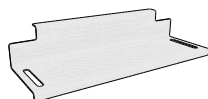

Shelf 3A01

Maximum load: 2 kg.

Finitura Finish	H. H.	P. D.	L. W.	Codice Code	Prezzo Price
Bianco Bianco	6,4	10,8	30	50LAB00003A01	
Piombo Piombo	6,4	10,8	30	50LAN00003A01	
Titanio Titanio	6,4	10,8	30	50LAT00003A01	

Porta mestoli 3A02

Portata massima: 2,3 kg.

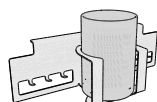

Ladles holder 3A02

Maximum load: 2,3 kg.

Finitura Finish	H. H.	P. D.	L. W.	Codice Code	Prezzo Price
Bianco Bianco	14,9	9,6	30	50LAB00003A02	
Piombo Piombo	14,9	9,6	30	50LAN00003A02	
Titanio Titanio	14,9	9,6	30	50LAT00003A02	

Porta bottiglia 3A07

Portata massima: 2 kg.

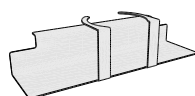

Bottle holder 3A07

Maximum load: 2 kg.

Finitura Finish	H. H.	P. D.	L. W.	Codice Code	Prezzo Price
Bianco Bianco	9,7	8,6	30	50LAB00003A07	
Piombo Piombo	9,7	8,6	30	50LAN00003A07	
Titanio Titanio	9,7	8,6	30	50LAT00003A07	

Oliera 3A08

Portata massima: 2 kg.

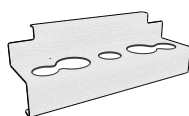

Dressing holder 3A08

Maximum load: 2 kg.

Finitura Finish	H. H.	P. D.	L. W.	Codice Code	Prezzo Price
Bianco Bianco	10,3	8,5	31,3	50LAB00003A08	
Piombo Piombo	10,3	8,5	31,3	50LAN00003A08	
Titanio Titanio	10,3	8,5	31,3	50LAT00003A08	

Porta spezie 3A03

Portata massima: 2 kg.

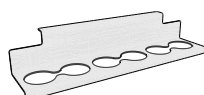

Kitchen paper roll holder

Maximum load: 2 kg.

Finitura Finish	H. H.	P. D.	L. W.	Codice Code	Prezzo Price
Bianco Bianco	15	8,1	31,3	50LAB00003A03	
Piombo Piombo	15	8,1	31,3	50LAN00003A03	
Titanio Titanio	15	8,1	31,3	50LAT00003A03	

Accessori LUMEN Accessories LUMEN

Porta spezie 3A21

Portata massima: 4 kg.

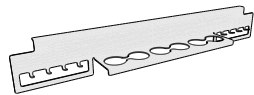

Spices holder 3A21

Maximum load: 4 kg.

Finitura Finish	H. H.	P. D.	L. W.	Codice Code	Prezzo Price
Bianco Bianco	15,4	8,2	60	50LAB00003A21	
Piombo Piombo	15,4	8,2	60	50LAN00003A21	
Titanio Titanio	15,4	8,2	60	50LAT00003A21	

Porta rotolo + spezie 3A22

Portata massima: 3,5 kg.



Paper roll + spices holder 3A22

Maximum load: 3,5 kg.

Finitura Finish	H. H.	P. D.	L. W.	Codice Code	Prezzo Price
Bianco Bianco	15,4	12,3	60	50LAB00003A22	
Piombo Piombo	15,4	12,3	60	50LAN00003A22	
Titanio Titanio	15,4	12,3	60	50LAT00003A22	

Porta rotolo + appendimestoli 3A23

Portata massima: 4 kg.

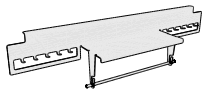

Paper roll + ladles holder 3A23

Maximum load: 4 kg.

Finitura Finish	H. H.	P. D.	L. W.	Codice Code	Prezzo Price
Bianco Bianco	10,3	8,5	31,3	50LAB00003A23	
Piombo Piombo	10,3	8,5	31,3	50LAN00003A23	
Titanio Titanio	10,3	8,5	31,3	50LAT00003A23	

Porta rotolo 3A05

Portata massima: 2 kg.

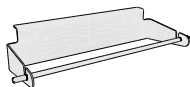

Paper roll holder 3A05

Maximum load: 2 kg.

Finitura Finish	H. H.	P. D.	L. W.	Codice Code	Prezzo Price
Bianco Bianco	5,5	10,4	28,5	50LAB00003A05	
Piombo Piombo	5,5	10,4	28,5	50LAN00003A05	
Titanio Titanio	5,5	10,4	28,5	50LAT00003A05	

Porta rotolo 3A06

Portata massima: 2 kg.

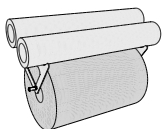

Paper roll holder 3A06

Maximum load: 2 kg.

Finitura Finish	H. H.	P. D.	L. W.	Codice Code	Prezzo Price
Bianco Bianco	12,9	14,9	28,5	50LAB00003A06	
Piombo Piombo	12,9	14,9	28,5	50LAN00003A06	
Titanio Titanio	12,9	14,9	28,5	50LAT00003A06	

Accessori LUMEN Accessories LUMEN

Barra appendimestoli L60 con 7 ganci 3A09-600

Portata massima: 6 kg.

60 cm wide ladle holder with 7 hooks 3A09-600

Maximum load: 6 kg.



Finitura Finish	H. H.	P. D.	L. W.	Codice Code	Prezzo Price
Bianco Bianco	7,4	4	60	50LAB03A09060	
Piombo Piombo	7,4	4	60	50LAN03A09060	
Titanio Titanio	7,4	4	60	50LAT03A09060	

Barra appendimestoli L90 con 8 ganci 3A09-900

Portata massima: 6 kg.

90 cm wide ladle holder with 8 hooks 3A09-900

Maximum load: 6 kg.



Finitura Finish	H. H.	P. D.	L. W.	Codice Code	Prezzo Price
Bianco Bianco	7,4	4	90	50LAB03A09090	
Piombo Piombo	7,4	4	90	50LAN03A09090	
Titanio Titanio	7,4	4	90	50LAT03A09090	

Barra appendimestoli L120 con 9 ganci 3A09-1200

Portata massima: 6 kg.

120 cm wide ladle holder with 9 hooks 3A09-1200

Maximum load: 6 kg.



Finitura Finish	H. H.	P. D.	L. W.	Codice Code	Prezzo Price
Bianco Bianco	7,4	4	120	50LAB03A09120	
Piombo Piombo	7,4	4	120	50LAN03A09120	
Titanio Titanio	7,4	4	120	50LAT03A09120	

Barra appendi e aggancia 3A10-300

Portata massima: 4 kg.

Accessories holder 3A10-300

Maximum load: 4 kg.

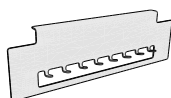

Finitura Finish	H. H.	P. D.	L. W.	Codice Code	Prezzo Price
Bianco Bianco	8,8	3,2	30	50LAB03A10030	
Piombo Piombo	8,8	3,2	30	50LAN03A10030	
Titanio Titanio	8,8	3,2	30	50LAT03A10030	

Barra appendi e aggancia 3A10-600

Portata massima: 6 kg.

Accessories holder 3A10-600

Maximum load: 6 kg.

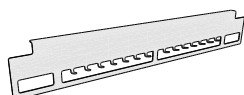

Finitura Finish	H. H.	P. D.	L. W.	Codice Code	Prezzo Price
Bianco Bianco	8,8	3,2	60	50LAB03A10060	
Piombo Piombo	8,8	3,2	60	50LAN03A10060	
Titanio Titanio	8,8	3,2	60	50LAT03A10060	

Accessori LUMEN Accessories LUMEN

Mensola 3F01

Portata massima: 2,5 kg.

Shelf 3F01

Maximum load: 2,5 kg.

Finitura Finish	H. H.	P. D.	L. W.	Codice Code	Prezzo Price
Bianco Bianco	7	10	30	50LAB00003F01	
Piombo Piombo	7	10	30	50LAN00003F01	
Titanio Titanio	7	10	30	50LAT00003F01	

Mensola 3F02

Portata massima: 4 kg.

Shelf 3F02

Maximum load: 4 kg.

Finitura Finish	H. H.	P. D.	L. W.	Codice Code	Prezzo Price
Bianco Bianco	7	10	45	50LAB00003F02	
Piombo Piombo	7	10	45	50LAN00003F02	
Titanio Titanio	7	10	45	50LAT00003F02	

Mensola con ganci 3F03

Portata massima: 2,5 kg.

Shelf with hooks 3F03

Maximum load: 2,5 kg.

Finitura Finish	H. H.	P. D.	L. W.	Codice Code	Prezzo Price
Bianco Bianco	7	10	30	50LAB00003F03	
Piombo Piombo	7	10	30	50LAN00003F03	
Titanio Titanio	7	10	30	50LAT00003F03	

Mensola con ganci 3F04

Portata massima: 4 kg.

Shelf with hooks 3F04

Maximum load: 4 kg.

Finitura Finish	H. H.	P. D.	L. W.	Codice Code	Prezzo Price
Bianco Bianco	7	10	45	50LAB00003F04	
Piombo Piombo	7	10	45	50LAN00003F04	
Titanio Titanio	7	10	45	50LAT00003F04	

Mensola doppia 3F05

Portata massima: 4,5 kg.

Double shelf 3F05

Maximum load: 4,5 kg.

Finitura Finish	H. H.	P. D.	L. W.	Codice Code	Prezzo Price
Bianco Bianco	13	11	34	50LAB00003F05	
Piombo Piombo	13	11	34	50LAN00003F05	
Titanio Titanio	13	11	34	50LAT00003F05	

Accessori LUMEN Accessories LUMEN

Mensola doppia con ganci 3F06

Portata massima: 4,5 kg.

Double shelf with hooks 3F06

Maximum load: 4,5 kg.

Finitura Finish	H. H.	P. D.	L. W.	Codice Code	Prezzo Price
Bianco Bianco	13	11	34	50LAB00003F06	
Piombo Piombo	13	11	34	50LAN00003F06	
Titanio Titanio	13	11	34	50LAT00003F06	

Portarotolo 3F07

Portata massima: 4,5 kg.

Paper roll holder 3F07

Maximum load: 4,5 kg.

Finitura Finish	H. H.	P. D.	L. W.	Codice Code	Prezzo Price
Bianco Bianco	13	11	49,5	50LAB00003F07	
Piombo Piombo	13	11	49,5	50LAN00003F07	
Titanio Titanio	13	11	49,5	50LAT00003F07	

Portarotolo con ganci 3F08

Portata massima: 4,5 kg.

Paper roll holder with hooks 3F08

Maximum load: 4,5 kg.

Finitura Finish	H. H.	P. D.	L. W.	Codice Code	Prezzo Price
Bianco Bianco	13	11	49,5	50LAB00003F08	
Piombo Piombo	13	11	49,5	50LAN00003F08	
Titanio Titanio	13	11	49,5	50LAT00003F08	

Portaspezie 3F09

Portata massima: 3 kg.

Spice holder 3F09

Maximum load: 3 kg.

Finitura Finish	H. H.	P. D.	L. W.	Codice Code	Prezzo Price
Bianco Bianco	7	10	32	50LAB00003F09	
Piombo Piombo	7	10	32	50LAN00003F09	
Titanio Titanio	7	10	32	50LAT00003F09	

Porta tablet 3F10

Portata massima: 3 kg.

Tablet holder 3F10

Maximum load: 3 kg.

Finitura Finish	H. H.	P. D.	L. W.	Codice Code	Prezzo Price
Bianco Bianco	6	14	32	50LAB00003F10	
Piombo Piombo	6	14	32	50LAN00003F10	
Titanio Titanio	6	14	32	50LAT00003F10	

Accessori LUMEN Accessories LUMEN

Portacalici per due bicchieri 3F11

Portata massima: 4 kg.

2 glasses rack 3F11

Maximum load: 4 kg.

Finitura Finish	H. H.	P. D.	L. W.	Codice Code	Prezzo Price
Bianco Bianco	60	9,5	45	50LAB00003F11	
Piombo Piombo	60	9,5	45	50LAN00003F11	
Titanio Titanio	60	9,5	45	50LAT00003F11	

Portacalici per quattro bicchieri 3F12

Portata massima: 4 kg.

4 glasses rack 3F12

Maximum load: 4 kg.

Finitura Finish	H. H.	P. D.	L. W.	Codice Code	Prezzo Price
Bianco Bianco	60	9,5	45	50LAB00003F12	
Piombo Piombo	60	9,5	45	50LAN00003F12	
Titanio Titanio	60	9,5	45	50LAT00003F12	