

Personalizzazioni

Customizations

Frontali

Specificare la posizione e il senso di apertura dell'anta.
I prezzi delle ante non includono la maniglia.

Frontals

Always specify on orders position and opening direction door.
Handle not included within door prices.



Frontale H. 12 cm

Frontal H. 12 cm

**NO JOY
NO BELLARIA**

***NO ASIA**

L. W.	Codice Code	0	1	2	3	4	5	6	7	8	9	10	11	12
44,7	OAN01170447	8	11	11	14	16	19	20	22	23	24	-	-	-
59,7	OAN01170597	9	12	14	17	20	21	22	25	26	27	-	-	-
* 74,7	OAN01170747	10	14	16	20	23	24	25	28	29	30	-	-	-
89,7	OAN01170897	11	15	20	24	28	29	30	34	36	38	-	-	-

72 75



Frontale H. 15 cm

Frontal H. 15 cm

**NO JOY
NO BELLARIA**

***NO ASIA**

L. W.	Codice Code	0	1	2	3	4	5	6	7	8	9	10	11	12
29,7	OAN01470297	8	11	11	21	18	21	22	23	24	25	-	-	-
39,7	OAN01470397	9	12	12	23	18	21	22	23	24	25	-	-	-
44,7	OAN01470447	9	12	12	15	18	21	22	23	24	25	-	-	-
59,7	OAN01470597	10	13	16	20	23	25	26	27	28	29	-	-	-
* 74,7	OAN01470747	12	15	18	22	26	29	30	32	34	36	-	-	-
89,7	OAN01470897	13	17	22	27	32	33	35	37	39	41	-	-	-
119,7	OAN01471197	18	24	31	38	45	46	48	50	53	56	-	-	-

75 81



Frontale H. 18 cm

Frontal H. 18 cm

**NO JOY
NO BELLARIA**

***NO ASIA**

L. W.	Codice Code	0	1	2	3	4	5	6	7	8	9	10	11	12
29,7	OAN01770297	8	11	11	13	15	19	20	21	22	23	-	-	-
39,7	OAN01770397	9	12	12	15	18	20	21	22	23	24	-	-	-
44,7	OAN01770447	10	13	14	17	20	21	22	23	24	25	-	-	-
59,7	OAN01770597	11	15	17	21	25	26	27	28	29	30	-	-	-
* 74,7	OAN01770747	13	17	20	25	29	30	32	34	36	38	-	-	-
89,7	OAN01770897	17	22	25	30	35	35	37	39	41	43	-	-	-
* 119,7	OAN01771197	24	31	35	42	49	49	51	54	57	60	-	-	-

72 75



Frontale H. 24 cm

Frontal H. 24 cm

L. W.	Codice Code	0	1	2	3	4	5	6	7	8	9	10	11	12
59,7	OAN02370597	14	19	21	25	29	48	50	56	59	62	-	-	-
74,7	OAN02370747	17	22	26	31	36	54	57	64	67	70	-	-	-
89,7	OAN02370897	24	32	33	38	42	57	60	66	69	72	-	-	-

72 75 81

Frontali

Specificare la posizione e il senso di apertura dell'anta.
I prezzi delle ante non includono la maniglia.

Frontals

Always specify on orders position and opening direction door.
Handle not included within door prices.



Frontale H. 33 cm

Frontal H. 33 cm

**NO JOY
NO BELLARIA**

***NO ASIA**

75 81

L. W.	Codice Code	0	1	2	3	4	5	6	7	8	9	10	11	12
44,7	OAN03270447	12	16	21	25	29	52	55	58	61	64	-	-	-
59,7	OAN03270597	14	19	27	32	37	56	59	62	65	68	-	-	-
* 74,7	OAN03270747	16	22	31	37	43	64	67	70	74	78	-	-	-
89,7	OAN03270897	24	32	38	46	53	71	75	79	83	87	-	-	-
119,7	OAN03271197	29	42	53	62	71	91	96	101	106	111	-	-	-



Frontale H. 36 cm

Frontal H. 36 cm

***NO ASIA**

72 75

L. W.	Codice Code	0	1	2	3	4	5	6	7	8	9	10	11	12
44,7	OAN03570447	15	20	22	27	32	49	51	57	60	63	-	-	-
59,7	OAN03570597	18	24	28	33	38	57	60	66	69	72	-	-	-
* 74,7	OAN03570747	21	28	32	38	44	66	69	76	80	84	-	-	-
89,7	OAN03570897	25	33	41	49	56	74	78	87	91	96	-	-	-
119,7	OAN03571197	29	38	53	63	73	90	95	105	110	116	-	-	-
149,7	OAN03571497	29	38	53	63	73	90	95	105	110	116	-	-	-
179,7	OAN03571797	29	38	53	63	73	90	95	105	110	116	-	-	-



Frontale H. 42 cm

Frontal H. 42 cm

NO JOY

NO BELLARIA

***NO ASIA**

81

L. W.	Codice Code	0	1	2	3	4	5	6	7	8	9	10	11	12
44,7	OAN04170447	-	-	30	32	34	44	46	48	50	53	-	-	-
59,7	OAN04170597	-	-	35	40	45	59	62	65	68	71	-	-	-
* 74,7	OAN04170747	-	-	40	46	52	68	71	75	79	83	-	-	-
89,7	OAN04170897	-	-	48	58	68	89	93	98	103	108	-	-	-
119,7	OAN04171197	-	-	60	76	91	119	125	131	138	145	-	-	-



Frontale H. 48 cm

Frontal H. 48 cm

***NO ASIA**

72 75 81

L. W.	Codice Code	0	1	2	3	4	5	6	7	8	9	10	11	12
44,7	OAN04770447	22	29	31	35	39	57	60	66	69	72	-	-	-
59,7	OAN04770597	22	29	36	43	50	71	75	82	86	90	-	-	-
* 74,7	OAN04770747	25	33	41	50	58	82	86	95	100	105	-	-	-
89,7	OAN04770897	31	41	50	60	69	90	95	105	110	116	-	-	-
119,7	OAN04771197	44	55	75	90	104	126	132	138	145	152	-	-	-
149,7	OAN04771497	44	55	75	90	104	126	132	138	145	152	-	-	-
179,7	OAN04771797	44	55	75	90	104	126	132	138	145	152	-	-	-

Frontali

Specificare la posizione e il senso di apertura dell'anta.
I prezzi delle ante non includono la maniglia.

Frontals

Always specify on orders position and opening direction door.
Handle not included within door prices.

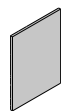

Frontale H. 60 cm

Frontal H. 60 cm

*NO ASIA

L. W.	Codice Code	0	1	2	3	4	5	6	7	8	9	10	11	12
44,7	0AN05970447	21	28	34	40	46	66	69	77	81	85			
59,7	0AN05970597	26	34	48	60	71	75	79	88	92	97			
* 74,7	0AN05970747	30	39	55	69	82	86	90	101	106	111			
89,7	0AN05970897	36	48	62	73	83	101	106	118	124	130			
119,7	0AN05971197	36	48	62	73	83	101	106	118	124	130			
149,7	0AN05971497	36	48	62	73	83	101	106	118	124	130			
179,7	0AN05971797	36	48	62	73	83	101	106	118	124	130			

72 75 81

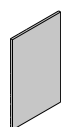

Frontale H. 72 cm

Frontal H. 72 cm

*NO BELLARIA

L. W.	Codice Code	0	1	2	3	4	5	6	7	8	9	10	11	12
* 14,7	0AN07170147	13	17	20	24	28	28	29	30	32	34			
29,7	0AN07170297	18	24	28	35	41	58	61	67	70	74			
39,7	0AN07170397	22	29	37	44	51	71	75	82	86	90			
44,7	0AN07170447	24	32	39	47	54	75	79	88	92	97			
59,7	0AN07170597	29	38	50	60	69	91	96	106	111	117			
74,7	0AN07170747	34	45	62	66	69	116	122	128	134	141			

72 75 81

Frontale H. 78 cm

Frontal H. 78 cm

NO JOY

NO BELLARIA
NO ASIA

L. W.	Codice Code	0	1	2	3	4	5	6	7	8	9	10	11	12
14,7	0AN07770147		-	24-	27	30	32	34	36	38	40			
29,7	0AN07770297		-	32-	38	44	55	58	61	64	67			
39,7	0AN07770397		-	40-	48	55	74	78	82	86	90			
44,7	0AN07770447		-	45-	52	59	83	87	91	96	101			
59,7	0AN07770597		-	54-	63	71	111	117	123	129	135			
74,7	0AN07770747		-	66-	76	85	138	145	152	160	168			

81

Frontale H. 96 cm

Frontal H. 96 cm

L. W.	Codice Code	0	1	2	3	4	5	6	7	8	9	10	11	12
29,7	0AN09570297	24	32	38	45	52	71	75	82	86	90			
39,7	0AN09570397	29	38	47	59	70	82	86	95	100	105			
44,7	0AN09570447	31	41	52	61	70	90	95	105	110	116			
59,7	0AN09570597	38	50	65	77	89	112	118	131	138	145			
74,7	0AN09570747	55	73	107	113	118	141	148	150	158	166			

72 75 81

Frontali

Specificare la posizione e il senso di apertura dell'anta.
I prezzi delle ante non includono la maniglia.

Frontals

Always specify on orders position and opening direction door.
Handle not included within door prices.

Frontale H. 120 cm

Frontal H. 120 cm

NO JOY

NO BELLARIA
NO ASIA

L. W.	Codice Code	0	1	2	3	4	5	6	7	8	9	10	11	12
44,7	0ANI1970447	-	-	75	87	98	128	134	141	148	155	-	-	-
59,7	0ANI1970597	-	-	85	98	110	140	147	154	162	170	-	-	-

81



Frontale H. 132 cm

Frontal H. 132 cm

L. W.	Codice Code	0	1	2	3	4	5	6	7	8	9	10	11	12
29,7	0ANI3170297	38	50	60	65	70	85	89	100	105	110	-	-	-
44,7	0ANI3170447	39	52	70	82	93	116	122	135	142	149	-	-	-
59,7	0ANI3170597	49	65	89	104	118	146	153	170	179	188	-	-	-
74,7	0ANI3170747	55	73	107	113	118	161	169	196	206	216	-	-	-

72 75

Frontale H. 138 cm

Frontal H. 138 cm

NO JOY

NO BELLARIA
NO ASIA

L. W.	Codice Code	0	1	2	3	4	5	6	7	8	9	10	11	12
29,7	0ANI3770297	-	-	63	69	75	98	103	108	113	119	-	-	-
44,7	0ANI3770447	-	-	78	95	112	147	154	162	170	179	-	-	-
59,7	0ANI3770597	-	-	99	125	150	196	206	216	227	238	-	-	-
74,7	0ANI3770747	-	-	120	154	188	245	257	270	284	298	-	-	-

81



Frontale H. 156 cm

Frontal H. 156 cm

NO JOY

NO BELLARIA
NO ASIA

L. W.	Codice Code	0	1	2	3	4	5	6	7	8	9	10	11	12
29,7	0ANI5570297	40	53	64	72	79	100	105	110	116	122	-	-	-
44,7	0ANI5570447	56	62	86	100	114	155	163	171	180	189	-	-	-
59,7	0ANI5570597	57	76	100	117	133	155	163	171	180	189	-	-	-
74,7	0ANI5570747	60	78	115	130	145	168	176	185	194	204	-	-	-

72 75 81

Frontali

Specificare la posizione e il senso di apertura dell'anta.
I prezzi delle ante non includono la maniglia.

Frontals

Always specify on orders position and opening direction door.
Handle not included within door prices.



Frontale H. 204 cm

Frontal H. 204 cm

L. W.	Codice Code	0	1	2	3	4	5	6	7	8	9	10	11	12
29,7	0AN20370297	45	59	76	91	105	142	149	156	164	172	-	-	-
59,7	0AN20370597	80	106	133	154	175	181	190	200	210	221	-	-	-
74,7	0AN20370747	92	122	153	177	201	208	218	229	240	252	-	-	-

NO JOY

NO BELLARIA
NO ASIA

72 75



Frontale H. 210 cm

Frontal H. 210 cm

L. W.	Codice Code	0	1	2	3	4	5	6	7	8	9	10	11	12
29,7	0AN20970297	-	-	87	104	121	163	171	180	189	198	-	-	-
59,7	0AN20970597	-	-	153	177	201	208	218	229	240	252	-	-	-
74,7	0AN20970747	-	-	176	204	231	239	251	264	277	291	-	-	-

NO JOY

NO BELLARIA
NO ASIA

81



Frontale H. 228 cm

Frontal H. 228 cm

L. W.	Codice Code	0	1	2	3	4	5	6	7	8	9	10	11	12
29,7	0AN22770297	52	68	87	104	121	163	171	180	189	198	-	-	-
59,7	0AN22770597	92	122	153	177	201	208	218	229	240	252	-	-	-
74,7	0AN22770747	106	140	176	204	231	239	251	264	277	291	-	-	-

NO JOY

NO BELLARIA
NO ASIA

72 75

Frontale H. 234 cm

Frontal H. 234 cm

L. W.	Codice Code	0	1	2	3	4	5	6	7	8	9	10	11	12
29,7	0AN23370297	-	-	92	112	131	171	180	189	198	208	-	-	-
59,7	0AN23370597	-	-	160	211	262	271	285	299	314	330	-	-	-
74,7	0AN23370747	-	-	184	243	301	312	328	344	361	379	-	-	-

NO JOY

NO BELLARIA
NO ASIA

81

Frontali a vetro Asia (inglesina) Asia english style frame doors

Specificare la posizione e il senso di apertura dell'anta.
I prezzi delle ante non includono la maniglia.

Always specify on orders position and opening direction door.
Handle not included within door prices.

Non sono possibili riduzioni.

Custom sized doors are not available.



Frontale H. 36 cm

Frontal H. 36 cm

L. W.	Codice Code	Prezzo
59,7	OAB0357059722	34
89,7	OAB0357089722	49

72 75

H.36: Anta senza inglesina
H.36: Door without english style frame



Frontale H. 48 cm

Frontal H. 48 cm

L. W.	Codice Code	Prezzo
59,7	OAB0477059722	111
89,7	OAB0477089722	150

72 75

H.36: Anta senza inglesina
H.36: Door without english style frame



Frontale H. 60 cm

Frontal H. 60 cm

L. W.	Codice Code	Prezzo
59,7	OAB0597059722	128
89,7	OAB0597089722	174

72 75

H.36: Anta senza inglesina
H.36: Door without english style frame



Frontale H. 72 cm

Frontal H. 72 cm

L. W.	Codice Code	Prezzo
44,7	OAB0717044722	120
59,7	OAB0717059722	144

72 75

H.36: Anta senza inglesina
H.36: Door without english style frame

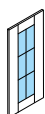

Frontale H. 96 cm

Frontal H. 96 cm

L. W.	Codice Code	Prezzo
44,7	OAB0957044722	151
59,7	OAB0957059722	183

72 75

H.36: Anta senza inglesina
H.36: Door without english style frame

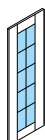

Frontale H. 132 cm

Frontal H. 132 cm

L. W.	Codice Code	Prezzo
44,7	OAB1317044722	198
59,7	OAB1317059722	244

72 75

H.36: Anta senza inglesina
H.36: Door without english style frame

Frontali a vetro Teca

Specificare la posizione e il senso di apertura dell'anta.
I prezzi delle ante non includono la maniglia.
I prezzi non includono le cerniere.
Non sono possibili riduzioni.

Teca frame doors

Always specify on orders position and opening direction door.
Handle not included within door prices.
Hinges are not included in the door price.
Custom sized doors are not available.

	Frontale H. 72 cm	Frontal H. 72 cm			
			L. W.	Codice Code	Prezzo
72 75 81			44,7	OAI0717044722	154
			59,7	OAI0717059722	166

	Frontale H. 78 cm	Frontal H. 78 cm			
			L. W.	Codice Code	Prezzo
81			44,7	OAI0777044722	163
			59,7	OAI0777059722	179

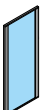
	Frontale H. 96 cm	Frontal H. 96 cm			
			L. W.	Codice Code	Prezzo
72 75 81			44,7	OAI0957044722	173
			59,7	OAI0957059722	192

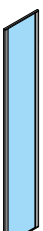
	Frontale H. 204 cm	Frontal H. 204 cm			
			L. W.	Codice Code	Prezzo
72 75			44,7	OAI2037044722	254
			59,7	OAI2037059722	289

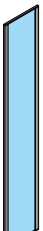
	Frontale H. 210 cm	Frontal H. 210 cm			
			L. W.	Codice Code	Prezzo
81			44,7	OAI2097044722	257
			59,7	OAI2097059722	292

Frontali a vetro Slim

Specificare la posizione e il senso di apertura dell'anta.
I prezzi delle ante non includono la maniglia.
I prezzi non includono le cerniere.
Non sono possibili riduzioni.

Slim frame doors

Always specify on orders position and opening direction door.
Handle not included within door prices.
Hinges are not included in the door price.
Custom sized doors are not available.



Frontale H. 48 cm

Frontal H. 72 cm

L. W.	Codice Code	Prezzo
44,7	OAI0477044435	154
59,7	OAI0477059435	166

78 81



Frontale H. 78 cm

Frontal H. 78 cm

L. W.	Codice Code	Prezzo
44,7	OAI0777044435	163
59,7	OAI0777059435	179

78 81

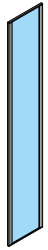

Frontale H. 210 cm

Frontal H. 210 cm

L. W.	Codice Code	Prezzo
44,7	OAI2097044435	257
59,7	OAI2097059435	292

78 81

Fianchi

Structural sides

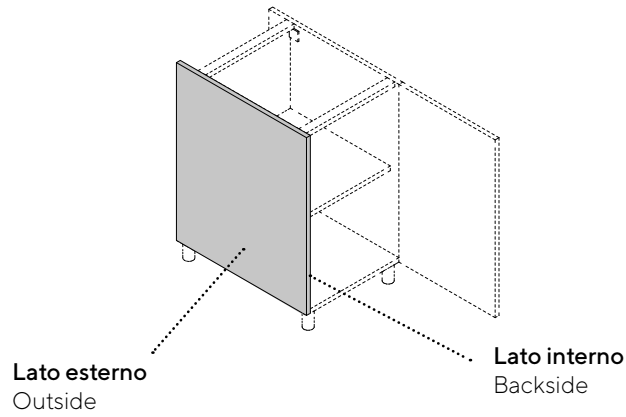

FIANCHI MONOFACCIALI sp. 1,9 cm / SINGLE FACE SIDE PANELS th 1,9 cm

Modello Modell	Fascia Group	Finitura lato interno Backside finish
ASIA	B	Bianco o grigio orione / White or grigio orione
TREND LACCATO OPACO	D	Bianco o grigio orione / White or grigio orione
TREND LACCATO LUCIDO	F	Bianco o grigio orione / White or grigio orione
ARIA TECH OPACO	D	Bianco o grigio orione / White or grigio orione
ARIA TECH LUCIDO	F	Bianco o grigio orione / White or grigio orione

FIANCHI BIFACCIALI sp. 1,9 cm. / DOUBLE FACE SIDE PANELS th 1,9 cm.

Modello Modell	Fascia Group	Finitura lato interno Backside finish
ARIA TECH OPACO	D	Uguale / Same finish
ARIA TECH LUCIDO	F	Uguale / Same finish
ASIA	L	Uguale / Same finish
BELLARIA LACCATO OPACO	D	Uguale / Same finish
COLIBRI NOBILITATO	A	Uguale / Same finish
COLIBRI NOBILITATO PLUS	C	Uguale / Same finish
COLIBRI MONOLACCATO	B	Nobilitato in tinta / Melamine same color*
JOY SETA	B	Uguale / Same finish
TREND NOBILITATO	C	Uguale / Same finish
TREND SETA	B	Uguale / Same finish
TREND FENIX	I	Uguale / Same finish
TREND LACCATO OPACO	D	Uguale / Same finish
TREND LACCATO LUCIDO	F	Uguale / Same finish
TREND LACCATO OPACO RAL	G	Uguale / Same finish
TREND LACCATO LUCIDO RAL	H	Uguale / Same finish
TREND LEGNO	E	Uguale / Same finish

*Bianco ottico, Grigio pepe con interno bianco
*Bianco ottico, grigio pepe with white back side

Fianchi

Structural sides

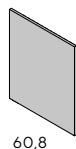

60,8

H.
H.

		SCocca Nobilitato
		BODY Melamine
24	OF01024060819	8
36	OF01036060819	8
* 39	OF01039060819	8
48	OF01048060819	14
60	OF01060060819	14
* 63	OF01063060819	14
72	OF01072060819	14
75	OF01075060819	14
78	OF01078060819	14
* 81	OF01081060819	14
96	OF01096060819	40
132	OF01132060819	40
138	OF01138060819	40
156	OF01156060819	40
204	OF01204060819	55
210	OF01210060819	55
228	OF01228060819	55
234	OF01234060819	55

* Misura disponibile solo per sistemi H75/H81
Size available only for H75/H81 systems



32,2

24	OF01024032219	4
36	OF01036032219	7
* 39	OF01039032219	7
48	OF01048032219	7
60	OF01060032219	11
* 63	OF01063032219	11
72	OF01072032219	11
* 75	OF01075032219	11
78	OF01078032219	11
* 81	OF01081032219	14
96	OF01096032219	26
120	OF01120032219	26
132	OF01132032219	34
138	OF01138032219	40
156	OF01156032219	29
204	OF01204032219	29
210	OF01210032219	29
228	OF01228032219	29
234	OF01234032219	29

* Misura disponibile solo per sistemi H75/H81
Size available only for H75/H81 systems

Maggiorazioni per fianchi strutturali finitura anta

Surcharges for structural sides

A	B	C	D	E	F	G	H	I	L
COLIBRI nobilitato	COLIBRI monolaccato JOY Seta TREND Seta	COLIBRI nobilitato metallo TREND nobilitato nobilitato segno	TREND Laccato opaco BELLARIA Laccato opaco ARIA TECH Laccato opaco	TREND Legno	TREND Laccato lucido ARIA TECH Laccato lucido			TREND Fenix	
COLIBRI Laminare RIVER Laminare	COLIBRI monolacquered JOY Silk ASIA TREND Silk	COLIBRI PLUS laminare JOY Melamine TREND Melamine TREND PLUS Melamine	TREND Matt lacquered BELLARIA Matt lacquered	TREND Wood	TREND Glossy lacquered ARIA TECH Glossy lacquered			TREND Fenix	

Bifacciale Both faced

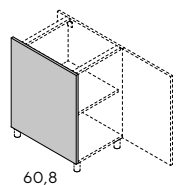

H.	H.	A	B	C	D	E	F	G	H	I	L
24/27	OFXX024060819	12	40	18	44	72	44			50	
36	OFXX036060819	12	40	18	-	72	-			50	
* 39	OFXX039060819	-	40	18	44	72	55			50	
48/51	OFXX048060819	12	40	18	44	-	99			-	
60	OFXX060060819	12	40	23	-	72	-			50	
* 63	OFXX063060819	-	40	23	58	72	99			50	
72	OFXX072060819	12	40	23	-	72	-			50	
* 75	OFXX075060819	-	40	23	72	72	110			50	
78	OFXX078060819	-	40	23	72	72	110			50	
* 81	OFXX081060819	-	40	23	72	-	110			63	
96	OFXX096060819	35	74	46	-	117	-			93	
132	OFXX132060819	35	79	46	-	117	-			99	
* 138	OFXX138060819	-	79	46	-	-	-			99	
156	OFXX138060819	43	83	54	-	-	-			104	
204	OFXX204060819	64	92	75	198	176	330			115	
* 210	OFXX210060819	-	92	75	198	-	330			115	
228	OFXX228060819	79	128	90	198	199	347			160	
* 234	OFXX234060819	-	128	90	198	-	352			160	

* Misura disponibile solo per sistemi H75/H81
Size available only for H75/H81 systems

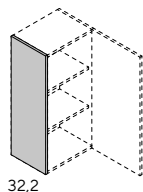

24/27	OFXX024032219	7	29	18	33	33	-			37	
36	OFXX036032219	7	29	18	33	33	-			37	
* 39	OFXX039032219	-	30	-	-	-	44			-	
48/51	OFXX048032219	7	30	18	33	39	-			38	
60	OFXX060032219	8	35	19	39	46	-			44	
* 63	OFXX063032219	-	-	-	-	-	56			-	
72	OFXX072032219	12	40	23	53	50	-			50	
* 75	OFXX075032219	-	40	23	53	72	66			50	
78	OFXX078032219										
* 81	OFXX081032219	-	40	23	53	50	66			50	
96	OFXX024032219										
120	OFXX120032219	35	71	-	66	117	-			89	
* 138	OFXX138032219	-	71	46	66	117	-			89	
156	OFXX156032219	43	71	46	80	-	-			89	
204	OFXX204032219	35	79	46	121	122	-			99	
* 210	OFXX210032219	-	79	46	-	122	-			99	
228	OFXX228032219	79	128	90	-	199	-			160	
234	OFXX234032219	79	128	90	-	199	-			160	

* Misura disponibile solo per sistemi H75/H81
Size available only for H75/H81 systems

Maggiorazioni per fianchi strutturali finitura anta

Surcharges for structural sides

Monofacciale Monoface

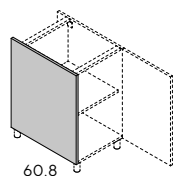

60,8

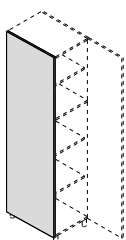

* Misura disponibile solo per sistemi H75/H81
Size available only for H75/H81 systems

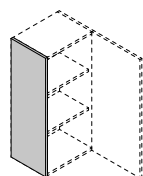

32,2

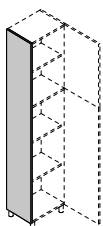

* Misura disponibile solo per sistemi H75/H81
Size available only for H75/H81 systems

H. H.		A	B ASIA	C	D TREND Laccato opaco ARIA TECH Laccato opaco	E	F TREND Laccato lucido ARIA TECH Laccato lucido	G	H	I	L
24/27	OFXX024060819		33		28		36				
36	OFXX036060819		33		28		53				
* 39	OFXX039060819		-		-		-				
48/51	OFXX048060819		33		28		70				
60	OFXX060060819		33		55		88				
* 63	OFXX063060819		-		-		-				
72	OFXX072060819		33		66		106				
* 75	OFXX075060819		-		-		-				
78	OFXX078060819		-		-		-				
* 81	OFXX081060819		-		-		-				
96	OFXX096060819		62		68		141				
132	OFXX132060819		66		84		194				
* 138	OFXX138060819		-		84		194				
156	OFXX156060819		-		111		221				
204	OFXX204060819		77		191		300				
* 210	OFXX210060819		-		191		300				
228	OFXX228060819		107		191		336				
* 234	OFXX234060819		-		191		336				
24/27	OFXX024032219		24		28		40				
36	OFXX036032219		24		28		40				
* 39	OFXX039032219		-		-		-				
48/51	OFXX048032219		25		28		40				
60	OFXX060032219		29		33		47				
* 63	OFXX063032219		-		-		-				
72	OFXX072032219		33		50		55				
* 75	OFXX075032219		-		-		-				
78	OFXX078032219		-		-		-				
* 81	OFXX081032219		-		-		-				
96	OFXX096032219		36		55		72				
120	OFXX120032219		-		54		87				
132	OFXX132032219		59		54		87				
* 138	OFXX138032219		48		54		76				
156	OFXX156032219		59		66		98				
204	OFXX204032219		66		101		129				
* 210	OFXX210032219		-		101		129				
228	OFXX228032219		107		101		144				
* 234	OFXX234032219		-		-		-				

Maggiorazioni per fianchi aggiuntivi finitura anta

Bifacciale Both faced

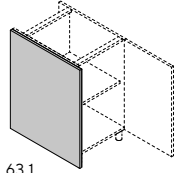

63,1

		A	B	C	D	E	F	G	H	I	L
		COLIBRI nobilitato	COLIBRI monolaccato JOY Seta TREND Seta	COLIBRI nobilitato metallo TREND nobilitato segno	TREND Laccato opaco BELLARIA Laccato opaco ARIA TECH Laccato opaco	TREND Legno	TREND Laccato lucido ARIA TECH Laccato lucido			TREND Fenix	
		COLIBRI Laminare RIVER Laminare	COLIBRI monolacquered JOY Silk ASIA TREND Silk	COLIBRI PLUS laminate JOY Melamine TREND Melamine TREND PLUS Melamine	TREND Matt lacquered BELLARIA Matt lacquered	TREND Wood	TREND Glossy lacquered			TREND Fenix	
H.											
H.											
84	OFXX084063119	12	33	-	68	-	300			114	
86	OFXX086063119	12	33	-	68	-	300			114	
87	OFXX087063119	12	33	29	68	176	300			114	
89	OFXX089063119	-	43	29	68	176	300			114	
90	OFXX090063119	12	33	75	191	176	300			114	

fianco a telaio asia



FIANCO A TELAIO ASIA

Il fianco a telaio Asia va applicato, come un normale fianco aggiuntivo, con viti dall'interno del mobile.

Disponibile per mobili del modello Asia di profondità 60,8 cm.

Non sono possibili riduzioni a misura

SIDE FRAME ASIA

The side frame panel has to be fixed, as a standard side panel, with screws from the inside of the cabinet.

It's available for 60,8 cm depth cabinets.

No customized sizes are available

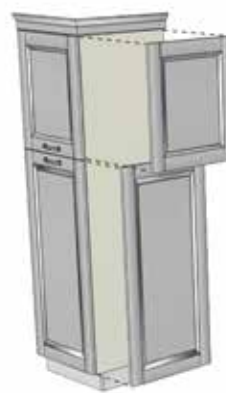

P. D. 60,8 cm



P. D. 32,2 cm

Modularità | Modularity



Misure ante | Door measures

	H 117	H 177	H 237	H 357	H 477	H 597	H 717	H 957	H 1317	H 2037
L 632										

■ Misure disponibili Available measures

fianco a telaio asia

Finiture | Finishing

asia

Materico laccato "Zero Gloss"
Lacquered materico "Zero Gloss"

Spessore Thickness **2,2 cm**

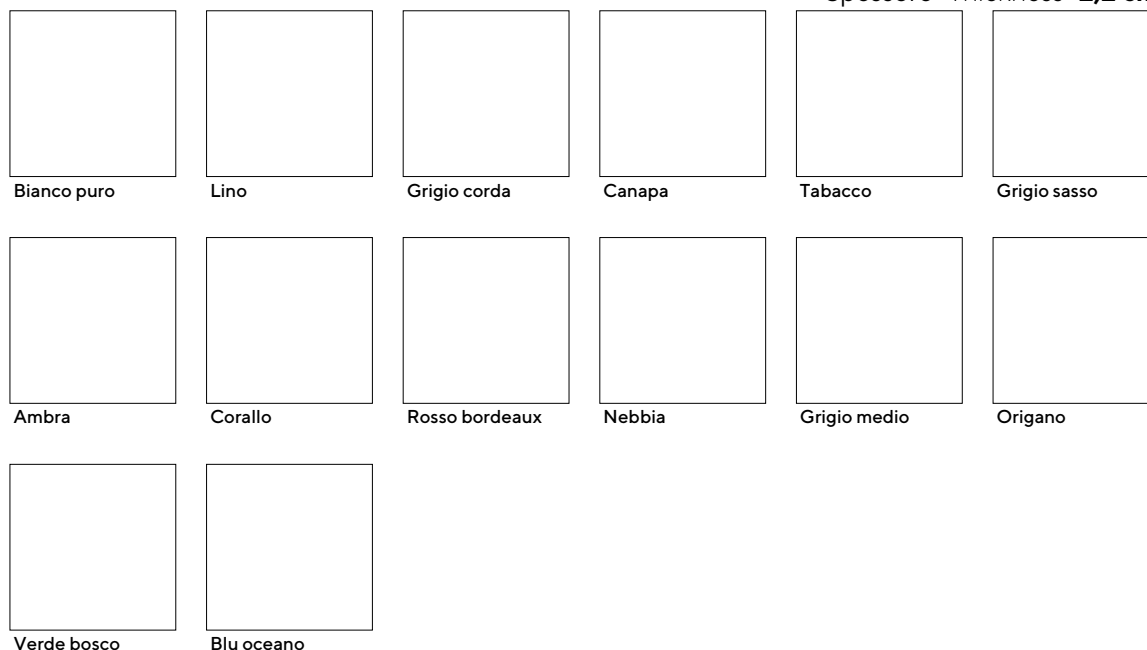

Non sono possibili riduzioni a misura
No customized sizes are available

Personalizzazioni
Customizations

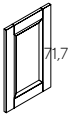
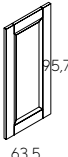
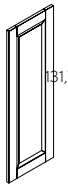
	H. H.	P. D.	Sp. Th.	Codice Code	Prezzo Price
 <p>Fianco a telaio ASIA H. 23,7 ASIA frame side panel H. 23,7</p>	23,7	63,5	2,2	1AA0237063522	45
 <p>Fianco a telaio ASIA H. 71,7 ASIA frame side panel H. 71,7</p>	71,7	63,5	2,2	1AA0717063522	78
 <p>Fianco a telaio ASIA H. 95,7 ASIA frame side panel H. 95,7</p>	95,7	63,5	2,2	1AA0957063522	103
 <p>Fianco a telaio ASIA H. 131,7 ASIA frame side panel H. 131,7</p>	131,7	63,5	2,2	1AA1317063522	135

fianco a telaio bellaria



FIANCO A TELAIO BELLARIA

Il fianco a telaio Bellaria va applicato, come un normale fianco aggiuntivo, con viti dall'interno del mobile.

Disponibile per mobili del modello Bellaria di profondità 60,8 cm.

Non sono possibili riduzioni a misura

SIDE FRAME BELLARIA

The side frame panel has to be fixed, as a standard side panel, with screws from the inside of the cabinet.

It's available for 60,8 cm depth cabinets.

No customized sizes are available

Modularità | Modularity

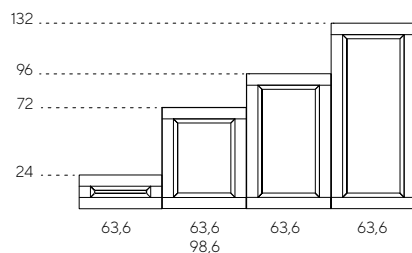

Misure ante | Door measures

	H 117	H 177	H 237	H 357	H 477	H 597	H 717	H 957	H 1317	H 2037
L 63,6										
L 98,6										

■ Misure disponibili Available measures

fianco a telaio bellaria

Finiture | Finishing

bellaria
Laccato opaco
Matt lacquered

Spessore Thickness **2,5 mm**





NCS-RAL opaco/lucido
Matt/glossy NCS-RAL



* Disponibile con maggiorazione.
Vedere retrocopertina.

* Available with surcharge.
See back cover.

Personalizzazioni
Customizations

		H. H.	P. D.	Sp. Th.	Codice Code	Prezzo Price
 <p>23,7 63,6</p>	Fianco a telaio BELLARIA H. 23,7 BELLARIA frame side panel H. 23,7	23,7	63,6		OAE0237063626	60
 <p>77,7 63,6 98,6</p>	Fianco a telaio BELLARIA H. 77,7 BELLARIA frame side panel H. 77,7	77,7	63,6		OAE0777063626	114
		77,7	98,6		OAE0777098626	120
 <p>95,7 63,6</p>	Fianco a telaio BELLARIA H. 95,7 BELLARIA frame side panel H. 95,7	95,7	63,6		OAE0957063626	141
 <p>131,7 63,6</p>	Fianco a telaio BELLARIA H. 131,7 BELLARIA frame side panel H. 131,7	131,7	63,6		OAE1317063626	183

Fuori misura

Aggiungere il sovrapprezzo indicato al prezzo del mobile di misure immediatamente superiori rispetto a quello richiesto. Qualora la lavorazione preveda l'intervento anche sull'anta verificarne, nelle pagine introduttive di ogni modello, la fattibilità. Per tutti i casi non contemplati qui di seguito è necessario consultare l'azienda per una eventuale richiesta di fattibilità ed il relativo preventivo. Verificare nelle pagine introduttive dei modelli eventuali limiti.

Customized elements

Add the following extra charges to the price of the furniture with measures immediately higher than the model required ones. In case of door customization, please check availability in the introductory pages of the relative kitchen model. In any case not covered below, please contact the company for availability and quotation. Please verify in the models introduction pages if there are limits in custom elements realization.

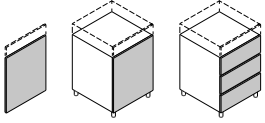
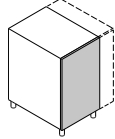
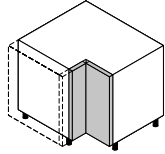
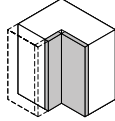
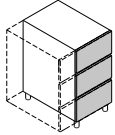
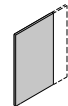
	Riduzione in altezza	Height reduction	H. min. cassetto = 118 mm H. min. cestone = 280 mm	H. min. drawer = 118 mm H. min. deep drawer = 280 mm	<div style="text-align: right;">Maggiorazioni Surcharges</div> <hr/> MAGXAA solo anta (no anta telaio) only door (no framed door) <hr/> MAGXA base / pensile / colonna base units / wall units / tall unit <hr/>
	Riduzione in larghezza	Width reduction			<div style="text-align: right;">Maggiorazioni Surcharges</div> <hr/> MAGXL base / pensile / colonna base units / wall units / tall unit <hr/>
	Riduzione in larghezza per base angolo ad L				<div style="text-align: right;">Maggiorazioni Surcharges</div> <hr/> MOSAG 1 taglio 1 cut <hr/>
	Riduzione in larghezza per pensile angolo ad L				<div style="text-align: right;">Maggiorazioni Surcharges</div> <hr/> BPLOP 1 taglio 1 cut <hr/>
	Riduzione in larghezza cassetto o cestone (escluso cassetti interni) Larghezza min. ottenibile: 30 cm.	Surcharge for reduction of drawer and deep drawer (excluded internal drawers) Min.width obtainable: 30 cm.			<div style="text-align: right;">Maggiorazioni Surcharges</div> <hr/> MAGXL 1 taglio 1 cut <hr/> 996C a cassetto o cestone each drawer or deep drawer <hr/>
	Riduzione in larghezza dell'anta	Reduction of the door			<div style="text-align: right;">Maggiorazioni Surcharges</div> <hr/> MAGXLA solo anta (no anta telaio) only door (no framed door) <hr/>

Fuori misura

Aggiungere il sovrapprezzo indicato al prezzo del mobile di misure immediatamente superiori rispetto a quello richiesto. Qualora la lavorazione preveda l'intervento anche sull'anta verificarne, nelle pagine introduttive di ogni modello, la fattibilità. Per tutti i casi non contemplati qui di seguito è necessario consultare l'azienda per una eventuale richiesta di fattibilità ed il relativo preventivo. Verificare nelle pagine introduttive dei modelli eventuali limiti.

Customized elements

Add the following extra charges to the price of the furniture with measures immediately higher than the model required ones. In case of door customization, please check availability in the introductory pages of the relative kitchen model. In any case not covered below, please contact the company for availability and quotation. Please verify in the models introduction pages if there are limits in custom elements realization.

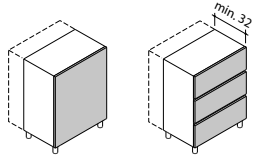
	Riduzione in profondità prof. fianco da 608 a 527 - prof. cassetto/cestone = 470 - prof. guide 500 prof. fianco da 506 a 376 - prof. cassetto/cestone = 320 - prof. guide 350 prof. fianco da 375 a 322 - prof. cassetto/cestone = 240 - prof. guide 270	Depth reduction side depth from 608 to 527 - drawer/deep drawer depth 470 - prof. guides 500 side depth from 506 to 376 - drawer/deep drawer depth 320 - prof. guides 350 side depth from 375 to 322 - drawer/deep drawer depth 240 - prof. guides 270
		Maggiorazioni Surcharges
		MAGXP base / pensile / colonna base units / wall units / tall unit

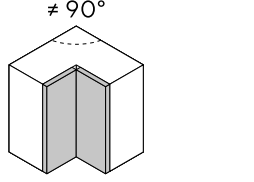
	Mobile ad angolo con fuorisquadra nei pensili ad angolo il fuorisquadra compreso tra 88 e 92 gradi consente l'intervento senza modificare le ante	Corner unit with irregular corner degree if the corner degree is between 88 to 92 degrees the doors will not be modified
		Maggiorazioni Surcharges
		BAFS1 basi / colonne ad angolo da 85° a 95° corner base / columns units from 85° to 95°
		BAFS2 others
		PAFS1 pensili ad angolo da 88° a 92° corner wall units from 88° to 92°
		PAFS2 oltre others

	Sagomatura, taglio speciale o scanso pilastro	
		Maggiorazioni Surcharges
		MOSAG base / pensile / colonna base units / wall units / tall unit

	Mobili smontati	Disassembled furniture
		Maggiorazioni Surcharges
		MOBSM base / pensile / colonna base units / wall units / tall unit

	Adattamento mobile non previsto dal configuratore grafico	Mobile adaptation not foreseen by the graphic configurator
		Maggiorazioni Surcharges
		ARTEK base / pensile / colonna base units / wall units / tall unit

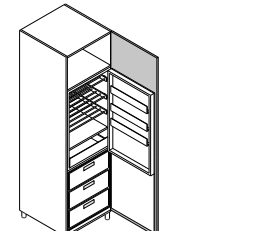
	Adattamento colonna per frigo cliente	Tall unit adaptation for customer refrigerator
		Maggiorazioni Surcharges
		ELCLI

Ripiani

Spessore 19 mm

Shelves

19 mm thick

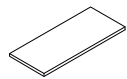

Ripiano/Tramezza nobilitato per mobili P 32,2 cm.

Melamine shelf/ fixed shelf for D. 32,2 cm. furnitures.

6500

6500

Ripiano P. 28 cm. / D. 28 cm shelf.				Tramezza P. 30,1 cm. / D. 30,1 cm fixed shelf.			
L. Mobile	L. W.	Codice Code	Prezzo Price	L. W.	Codice Code	Prezzo Price	
15	11	1RP1011028019	8	-	-	-	
30	26	1RP1026028019	10	26	1TRA026130619	4	
40	36	1RP1026028019	10	-	-	-	
45	41	1RP1041028019	12	41	1TRA041130619	5	
60	56	1RP1056028019	14	56	1TRA056130619	6	
75	71	1RP1071028019	15	71	1TRA071130619	9	
80	76	1RP1076028019	15	-	-	-	
90	86	1RP1086028019	15	86	1TRA086130619	10	
120	116	1RP116028019	19	-	-	-	

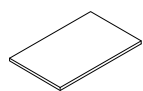

Ripiano nobilitato P. 44 cm. Per base/colonna/pensile P. 60,8 cm. D. 44 cm. melamine shelf for base /tall unit /wall unit D. 60,8 cm.

Ripiano P. 44 cm. / D. 44 cm shelf.				Tramezza P. 50,6 cm./ D. 50,6 cm fixed shelf.			
L. Mobile	L. W.	Codice Code	Prezzo Price	L. W.	Codice Code	Prezzo Price	
15	11	1RP1011044019	10	-	-	-	
30	26	1RP1026044019	10	26	1TRA026150619	9	
40	36	1RP1036044019	10	-	-	-	
45	41	1RP1041044019	15	41	1TRA041150619	7	
60	56	1RP1056044019	20	56	1TRA056150619	9	
75	71	1RP1071044019	24	71	1TRA071150619	14	
80	76	1RP1076044019	15	-	-	-	
90	86	1RP1086044019	22	86	1TRA086150619	14	
120	116	1RP116044019	28	-	-	-	

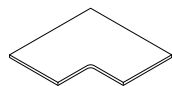

Ripiano nobilitato ad angolo

Melamine shelf for corner

L. W.	Codice Code	Prezzo Price
66 x 66	1RP4066166119	74
91x91	1RP4087987919	113

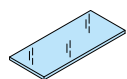

Ripiano in vetro P. 26,2 cm. per pensile/colonna P. 32,2 cm. finitura fumè

Glass shelf D. 26,2 cm. for wall unit/tall unit D. 32,2 cm. smoked finish

L. W.	Codice Code	Prezzo Price
40,4	1RPF040426208	22
55,4	1RPF055426208	22
85,4	1RPF085426208	23

Zoccoli

Lunghezza massima 400 cm.
Lo zoccolo non è compreso nel prezzo del mobile.

Plinths

Max length 400 cm.
Plinth is not included in the price of the furnitures.

Standard

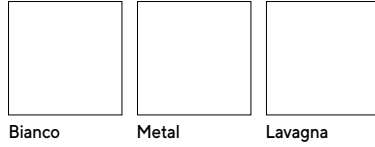

Bianco Metal Lavagna

Laccato opaco

Matt lacquered



Bianco puro Lino Pergamena Grigio corda Canapa Tabacco Fango Grigio sasso Quarzo

Disponibili allo stesso prezzo delle finiture standard
Available at the same price as the standard finishes

Gli zoccoli non sono disponibili nei colori RAL-NCS
Plinths are not available on RAL-NCS colours



Carbone Ambra Corallo Rosso bordeaux Grigio cenere Nebbia Grigio medio Fumo Ebano

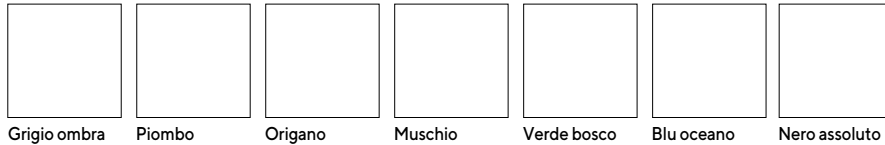

Grigio ombra Piombo Origano Muschio Verde bosco Blu oceano Nero assoluto

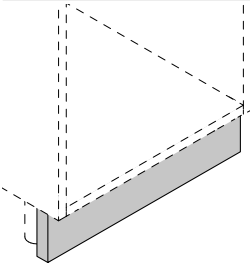

Zoccolo frontale

Frontal plinth

U.M. U.M.	H. H.	Codice Code	Prezzo Price
al mtl by the lm	8	TZL0839AM01	-
al mtl by the lm	12	TZL1239AM01	-
al mtl by the lm	15	TZL1539AM01	-
Cad. Each	8	9890__08	-
Cad. Each	12	9890__12	-
Cad. Each	15	9890__15	-

Giunzione lineare
Linear joint

Giunzione lineare
Linear joint

Giunzione lineare
Linear joint

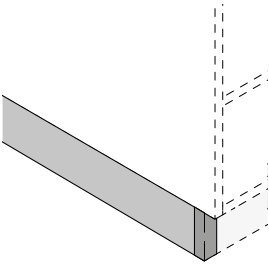

Zoccolo laterale

Side plinth

Da conteggiare separatamente rispetto al prezzo del mobile.

To be calculated separately from the price of the furniture.

U.M. U.M.	H. H.	Codice Code	Prezzo Price
al mtl by the lm	8	TZL0839AM01	-
al mtl by the lm	12	TZL1239AM01	-
al mtl by the lm	15	TZL1539AM01	-
Cad. Each	8	98902A08	-
Cad. Each	12	98902A12	-
Cad. Each	15	98902A15	-

Giunzione angolare
Corner joint

Giunzione angolare
Corner joint

Giunzione angolare
Corner joint

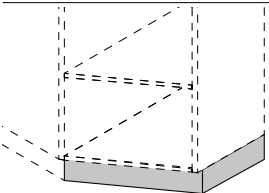

Zoccolo per terminale con anta

Plinth for end unit with door

Da conteggiare separatamente rispetto al prezzo del mobile

To be calculated separately from the price of the furniture

U.M. U.M.	H. H.	Codice Code	Prezzo Price
al mtl by the lm	8	TZL0839AM01	-
al mtl by the lm	12	TZL1239AM01	-
al mtl by the lm	15	TZL1539AM01	-
Cad. Each	8	OFER36M0308	-
Cad. Each	12	OFER36M0312	-
Cad. Each	15	OFER36M0315	-

Angolo variabile
Variable corner

Angolo variabile
Variable corner

Angolo variabile
Variable corner

Maniglie

Handles

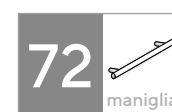

Maggiorazione maniglie

Il sovrapprezzo deve essere aggiunto al costo del mobile per ogni maniglia richiesta.

Surcharge handles

Surcharged price has to be added to the price of the furniture.









		Anta Door	Passo Interaxe	Lungh. Length	H. cm. H. cm.	Codice Code	Sovrapprezzo Surcharges
	UGO	Tutte All	19,2	25,2	3	CO5	0
	Spazzolato Brushed						
	TOKIO	Tutte All	16	17	2,8	TOK	0
	Cromo Chrome						
	SPIKE						
	Lavagna Lavagna	30	16	18	2,5	SK2	0
		40/45/60 90/120	32	34	2,5	SK3	+8
	CALIFORNIA						
	Cromo Chrome	30	16	20	2,8	CF1	0
		40/45/60 90/120	32	36	2,8	CF2	+9
	YORK	15/30	6,4	7,8	3	YK1	0
	Cromo Chrome	30	16	17,4	3	YK2	0
		40/45/60 90/120	32	33,4	3	YK3	+3
	SURF						
	Cromo Chrome	30	16	17,2	3	SR1	0
		40/45/60 90/120	32	33,2	3	SR2	+7
	BROOKLYN	Tutte All	19,2	20,5	3,4	BR1	0
	Spazzolato Brushed						
	MONACO	15	3,2	4,2	3	EU7	0
	Inox Stainless	30	16	17	3	EU3	0
		40/45	19,2	20,2	3	EU2	0
		60	35,2	36,2	3	EU4	+11
		90	44,8	45,8	3	EU5	+14
		120	64	65	3	EU6	+21

Maggiorazione maniglie

Il sovrapprezzo deve essere aggiunto al costo del mobile per ogni maniglia richiesta.

Surcharge handles

Surcharged price has to be added to the price of the furniture.



		Anta Door	Passo Interaxe	Lungh. Length	H. cm. H. cm.	Codice Code	Sovrapprezzo Surcharges
	CHEF Spazzolato Brushed	Tutte All	16	17,2	3	PA1	0
	BRIDGE Spazzolato Brushed	Tutte All	16	20,5	2,6	BG1	0
	COBRA Cromo Chrome	Tutte All	16	20	2,8	CRB	0
	FILO Inox Stainless	40/45	19,2	22,2	3	FL3	+10
		60	35,2	38,2	3	FL5	+13
	PRISMA Nero Black	Tutte All	16	20	2,1	PM2	+5
	PRISMA Titanio Titanium	Tutte All	16	20	2,1	PM1	+5
	QUEENS Ferro Fer	15/30	16	18,5	2,5	QE2	+3
		40/45/60 90/120	32	34,5	2,5	QE3	+8
	GIACARTA Peltro Pewter	Tutte All	16	17,8	2,8	GKR	+7
	MANILA Bronzo opaco martellato Matt hammered bronze	Tutte All	16	19	2,2	MNL	+7

Maggiorazione maniglie

Il sovrapprezzo deve essere aggiunto al costo del mobile per ogni maniglia richiesta.

Surcharge handles

Surcharged price has to be added to the price of the furniture.

		Anta Door	Passo Interaxe	Lungh. Length	H. cm. H. cm.	Codice Code	Sovrapprezzo Surcharges
	MADISON Titanio Titanium	Tutte All	12,8	14	2,8	MDT	0
	UGO Spazzolato Brushed	Tutte All	-	Ø1,4	3	C06	0
	GLOBO Frassino Ash	Tutte All	-	Ø5,2	2,5	GLB	0

Maggiorazione maniglie

Il sovrapprezzo deve essere aggiunto al costo del mobile per ogni maniglia richiesta.

Surcharge handles

Surcharged price has to be added to the price of the furniture.

	Anta Door	Passo Interaxe	Lungh. Length	H. cm. H. cm.	Codice Code	Sovrapprezzo Surcharges
 <p>STEP Nero ossidato Oxidized black</p>	15	5	7	3,8	STP007	+3
	30	20	22	3,8	STP022	+6
	40	30	32	3,8	STP032	+9
	45	35	37	3,8	STP037	+10

 <p>STEP Con supporto centrale With central support Nero ossidato Oxidized black</p>	60	50	52	3,8	STP052	+14
	90	80	82	3,8	STP082	+20
	120	110	112	3,8	STP112	+30

 <p>LONG Solo per anta intera (o doppia anta spinata) Full-height door only (or double door joined)</p>	Metal / Metal	149	150	45	LNМ	+53
	Nero / Black	149	150	45	LNN	+53

Finiture Finishing



Metal



Nero

Gola

Groove profile





Standard
Standard

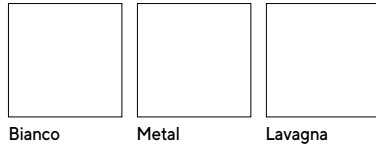

Bianco Metal Lavagna

Laccato opaco
Matt lacquered

Disponibili allo stesso prezzo delle finiture standard
Available at the same price as the standard finishes

Le gole non sono disponibili nei colori RAL-NCS
Gola profiles are not available on RAL-NCS colours

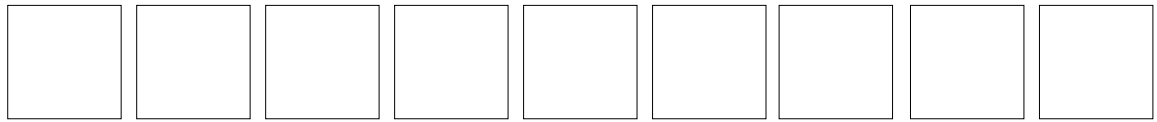

Bianco puro Lino Pergamena Grigio corda Canapa Tabacco Fango Grigio sasso Quarzo

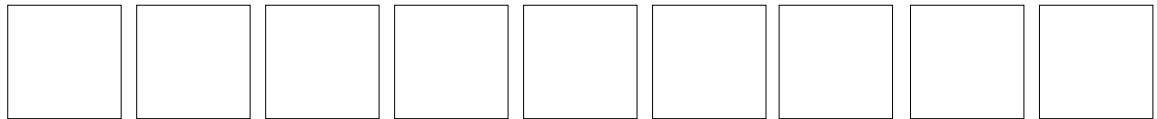

Carbone Ambra Corallo Rosso bordeaux Grigio cenere Nebbia Grigio medio Fumo Ebano

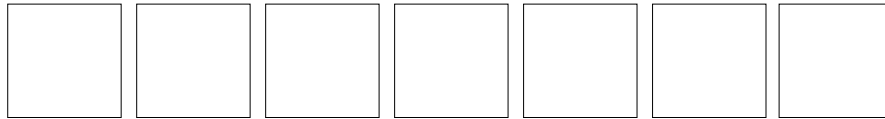

Grigio ombra Piombo Origano Muschio Verde bosco Blu oceano Nero assoluto

Sistema gola Blues

La gola non è compresa nel prezzo dei mobili e deve essere sempre aggiunta a parte.

Groove systems Blues

Grip profile is not included in the list price of the furnitures and has to be always added separately.

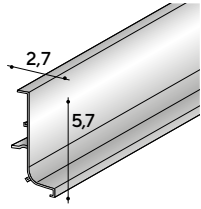
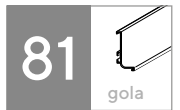

Gola sottotop

Main groove profile

U.M. U.M.	H. H.	L. L.	Codice Code	Prezzo Price
Cad. Each	5,7	434	GLB57410M05	-
al mtl. by the lmt	5,7		GLB57410M01	-

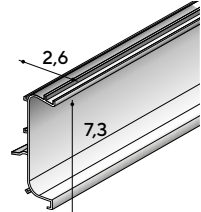

Gola intermedia per cassetiera

Intermediate groove profile for drawer-pack unit

U.M. U.M.	H. H.	L. L.	Codice Code	Prezzo Price
al ml by the ml	7,3		GLC73410M01	-



Coppia di tappi per gola intermedia base con cassetti

Pair of caps for intermediate groove drawer-pack unit

U.M. U.M.	H. H.	L. L.	Codice Code	Prezzo Price
1 coppia 1 pair			OFER22M03	-

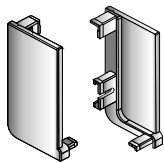

Coppia di tappi per gola sottotop

Di serie su fianchi in finitura scocca

Main groove profile

Standard on sides in body finish

U.M. U.M.	H. H.	L. L.	Codice Code	Prezzo Price
1 coppia 1 pair			OFER67M03	-

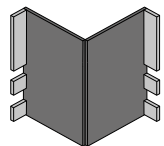

Angolo di giunzione 90°

L'angolo di giunzione è fornito di serie con la base angolo.

90° Corner joint

Corner joint is always supplied with the corner base unit.

	U.M. U.M.	H. H.	L. L.	Codice Code	Prezzo Price
Lavagna	Cad. Each			9GA2A00000LV1	-
Metal	Cad. Each			9GA2A00000MET	-
Bianco	Cad. Each			9GA2A00000BA1	-

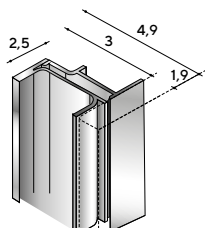

Gola verticale laterale

Vertical side groove profile

	U.M. U.M.	H. H.	L. L.	Codice Code	Prezzo Price
75	Cad. Each	132	4,9	GVT13249M01	-
75	Cad. Each	204	4,9	GVT20449M01	-
75	Cad. Each	228	4,9	GVT22849M01	-
81	Cad. Each	138	4,9	GVT13849M01	-
81	Cad. Each	210	4,9	GVT21049M01	-
81	Cad. Each	234	4,9	GVT23449M01	-

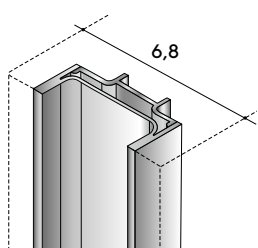

Gola verticale intermedia

Vertical intermediate groove profile

	U.M. U.M.	H. H.	L. L.	Codice Code	Prezzo Price
75	Cad. Each	132	6,8	GVI13268M01	-
75	Cad. Each	204	6,8	GVI20468M01	-
75	Cad. Each	228	6,8	GVI22868M01	-
81	Cad. Each	138	6,8	GVI13868M01	-
81	Cad. Each	210	6,8	GVI21068M01	-
81	Cad. Each	234	6,8	GVI23468M01	-

Fianco a C terminale gola

In composizioni con isola/penisola si possono utilizzare i fianchi terminali gola mantenendo la stessa estetica frontale anche lateralmente e sul retro.

"C" groove end side panel

In case of isle/peninsula kitchens, groove end side panels can be used to keep the same front look also on side and back.

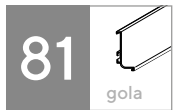

Disponibile per i seguenti modelli:

- **Colibri** (non con maniglia integrata)
- **Trend** (non con maniglia integrata)
- **Aria tech**

Available for models:

- **Colibri** (not with integrated handle)
- **Trend** (not with integrated handle)
- **Aria tech**

Lo spezzone di gola laterale viene conteggiato separatamente e non è incluso nel prezzo del fianco.

The end side panel groove is calculated separately and it's not included in the end side panel price.

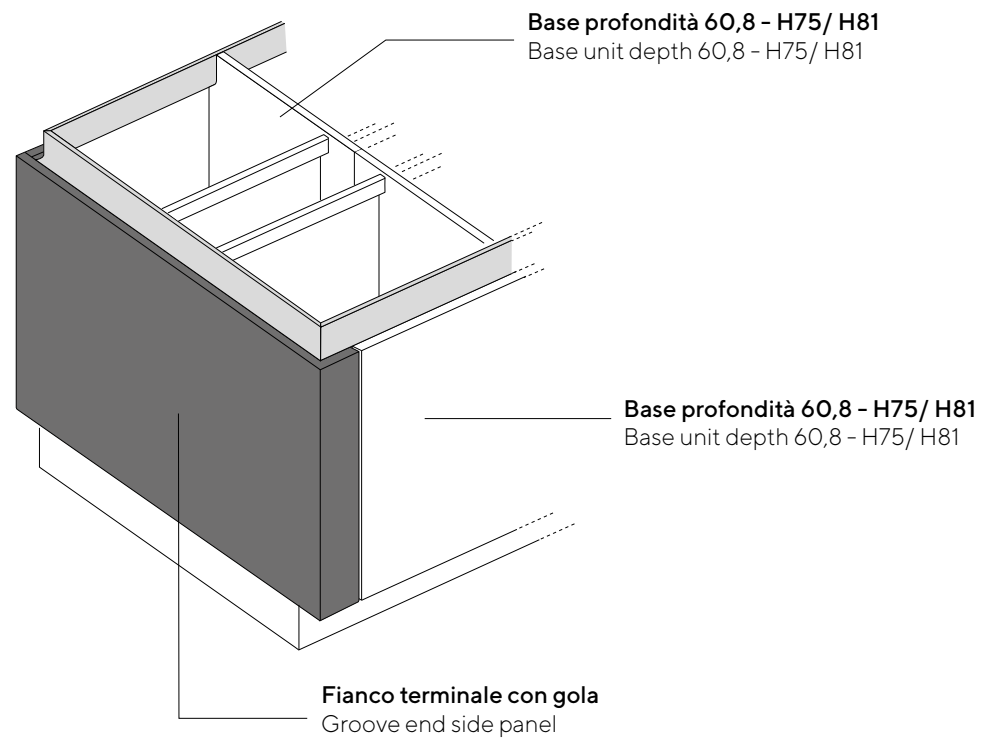

Fianco a C terminale gola

In composizioni con isola/penisola si possono utilizzare i fianchi terminali gola mantenendo la stessa estetica frontale anche lateralmente e sul retro.

"C" groove end side panel

In case of isle/peninsula kitchens, groove end side panels can be used to keep the same front look also on side and back.



Fianco terminale con gola sistema H75

Groove end side panel for H75 system

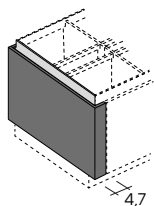

Profondità Depth	Codice Code	0	1	2	3	4	5	6	7	8	9	10	11	12
60,8+32,2 (top prof. 99)	OBXGC075AF19	147	157	166										
60,8+42,2 (top prof. 109)	OBXGC075AG19	162	174	183										
60,8+60,8 (top prof. 127,6)	OBXGC075AH19	185	198	209										

Fianco terminale con gola sistema H75

Groove end side panel for H75 system

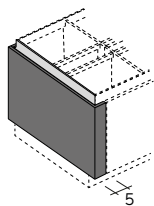

Profondità Depth	Codice Code	0	1	2	3	4	5	6	7	8	9	10	11	12
60,8+32,2 (top prof. 99)	OBXGC075AF22				-	239	268	281	-	-	-	-	-	-
60,8+42,2 (top prof. 109)	OBXGC075AG22				-	264	295	310	-	-	-	-	-	-
60,8+60,8 (top prof. 127,6)	OBXGC075AH22				-	312	345	362	-	-	-	-	-	-

Fianco terminale con gola sistema H81

Groove end side panel for H81 system

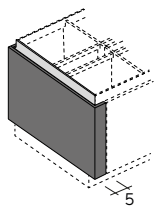

Profondità Depth	Codice Code	0	1	2	3	4	5	6	7	8	9	10	11	12
60,8+32,2 (top prof. 99)	OBXGC081AF22				-	258	288	302	-	-	-	-	-	-
60,8+42,2 (top prof. 109)	OBXGC081AG22				-	286	318	334	-	-	-	-	-	-
60,8+60,8 (top prof. 127,6)	OBXGC081AH22				-	336	374	393	-	-	-	-	-	-

Gola per fianco terminale (completa di due giunzioni spigolo)

Groove for end side panel (complete with two corner joints)

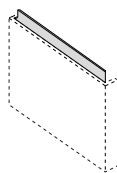

Profondità Depth	Codice Code	Prezzo Price
60,8+32,2 (top prof. 99)	GLB57093GC2	
60,8+42,2 (top prof. 109)	GLB57103GC2	
60,8+60,8 (top prof. 127,6)	GLB57122GC2	

Finiture | Finishing

Standard
Standard



Bianco Metal Lavagna

Laccato opaco
Matt lacquered



Bianco puro Lino Pergamena Grigio corda Canapa Tabacco Fango Grigio sasso Quarzo

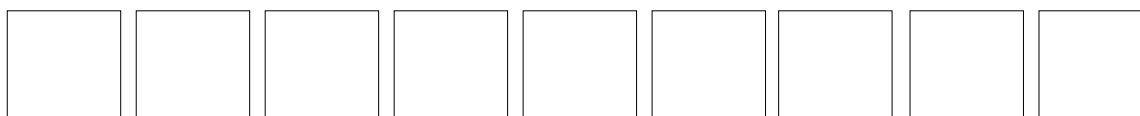

Carbone Ambra Corallo Rosso bordeaux Grigio cenere Nebbia Grigio medio Fumo Ebanò

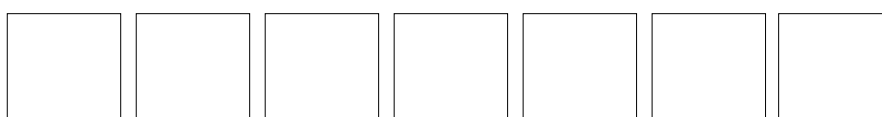

Grigio ombra Piombo Origano Muschio Verde bosco Blu oceano Nero assoluto

Fianco a C terminale gola

In composizioni con isola/penisola si possono utilizzare i fianchi terminali gola mantenendo la stessa estetica frontale anche lateralmente e sul retro.

"C" groove end side panel

In case of isle/peninsula kitchens, groove end side panels can be used to keep the same front look also on side and back.



Disponibile per i seguenti modelli:

- **Bellaria**

Available for models:

- **Bellaria**

Lo spezzone di gola laterale viene conteggiato separatamente e non è incluso nel prezzo del fianco.

The end side panel groove is calculated separately and it's not included in the end side panel price.

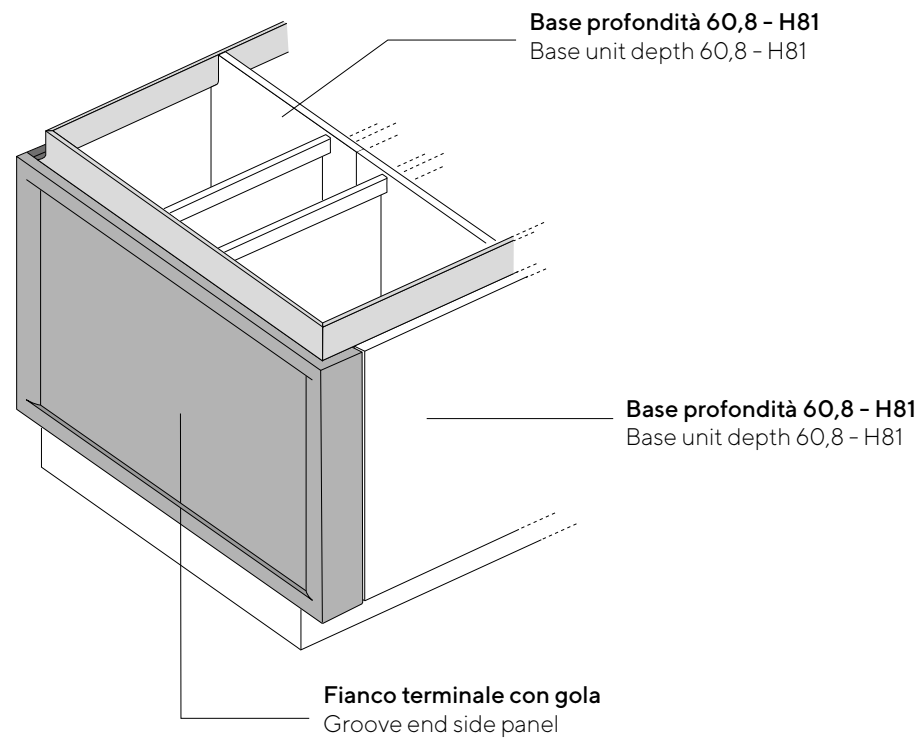

Fianco a C terminale gola

In composizioni con isola/penisola si possono utilizzare i fianchi terminali gola mantenendo la stessa estetica frontale anche lateralmente e sul retro.

"C" groove end side panel

In case of isle/peninsula kitchens, groove end side panels can be used to keep the same front look also on side and back.

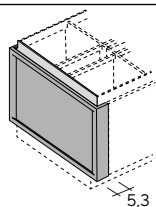

Fianco terminale con gola sistema H81

Groove end side panel for H81 system

Profondità Depth	Codice Code	0	1	2	3	4	5	6	7	8	9	10	11	12
60,8+32,2 (top prof. 99)	OBXGC081AF26	-	-	179	-	258	288	302	-	-	-	-	-	-
60,8+42,2 (top prof. 109)	OBXGC081AG26	-	-	198	-	286	318	334	-	-	-	-	-	-
60,8+60,8 (top prof. 127,6)	OBXGC081AH26	-	-	226	-	336	374	393	-	-	-	-	-	-

Gola per fianco terminale (completa di due giunzioni spigolo)

Groove for end side panel (complete with two corner joints)

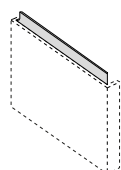

Profondità Depth	Codice Code	Prezzo Price
60,8+32,2 (top prof. 99)	GLB57093GC2	
60,8+42,2 (top prof. 109)	GLB57103GC2	
60,8+60,8 (top prof. 127,6)	GLB57122GC2	

Finiture | Finishing

Standard
Standard



Bianco Metal Lavagna

Laccato opaco
Matt lacquered



Bianco puro Lino Pergamena Grigio corda Canapa Tabacco Fango Grigio sasso Quarzo



Carbone Ambra Corallo Rosso bordeaux Grigio cenere Nebbia Grigio medio Fumo Ebano



Grigio ombra Piombo Origano Muschio Verde bosco Blu oceano Nero assoluto

Fianco a L terminale gola

In composizioni con isola/penisola si possono utilizzare i fianchi terminali gola mantenendo la stessa estetica frontale anche lateralmente e sul retro.

"L" groove end side panel

In case of isle/peninsula kitchens, groove end side panels can be used to keep the same front look also on side and back.



Disponibile per i seguenti modelli:

- **Colibrì** (non con maniglia integrata)
- **Trend** (non con maniglia integrata)
- **Aria tech**

Available for models:

- **Colibrì** (not with integrated handle)
- **Trend** (not with integrated handle)
- **Aria tech**

Lo spezzone di gola laterale viene conteggiato separatamente e non è incluso nel prezzo del fianco.

The end side panel groove is calculated separately and it's not included in the end side panel price.

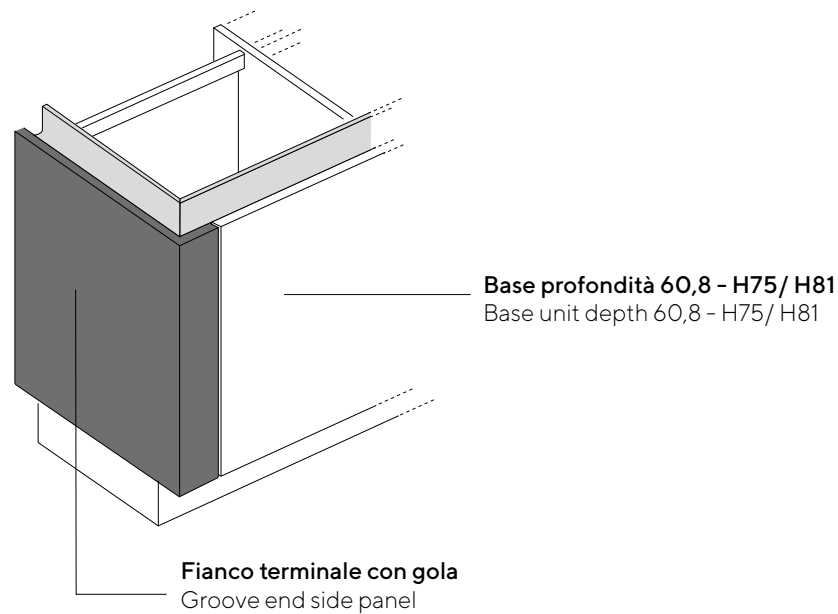

Fianco a L terminale gola

In composizioni con isola/penisola si possono utilizzare i fianchi terminali gola mantenendo la stessa estetica frontale anche lateralmente e sul retro.

"L" groove end side panel

In case of isle/peninsula kitchens, groove end side panels can be used to keep the same front look also on side and back.

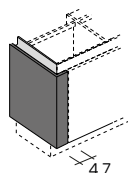

Fianco terminale con gola per sistema H75

Groove end side panel for H75 system

Profondità Depth	Codice Code	0	1	2	3	4	5	6	7	8	9	10	11	12
60,8 (top prof. 63,8)	OBXGLO75AL19	147	157	166										

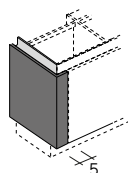

Fianco terminale con gola per sistema H75

Groove end side panel for H75 system

Profondità Depth	Codice Code	0	1	2	3	4	5	6	7	8	9	10	11	12
60,8 (top prof. 63,8)	OBXGLO75AL22				-	239	268	281	-	-	-	-	-	-

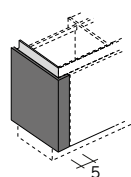

Fianco terminale con gola per sistema H81

Groove end side panel for H81 system

Profondità Depth	Codice Code	0	1	2	3	4	5	6	7	8	9	10	11	12
60,8 (top prof. 63,8)	OBXGLO81AL22				-	258	288	302	-	-	-	-	-	-

Gola per fianco terminale (completa di giunzione spigolo)

Groove for end side panel (complete with corner joint)

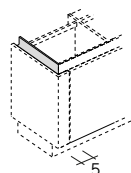

SX/LH

Verso Sense	Profondità Depth	Codice Code	Prezzo Price
SX	60,8	GLB57066GCS	
LH	(top prof. 63,8)		
DX	60,8	GLB57066GCD	
RH	(top prof. 63,8)		

Finiture | Finishing

Standard

Standard

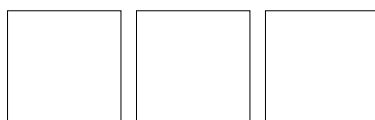

Bianco Metal Lavagna

Laccato opaco

Matt lacquered



Bianco puro Lino Pergamena Grigio corda Canapa Tabacco Fango Grigio sasso Quarzo

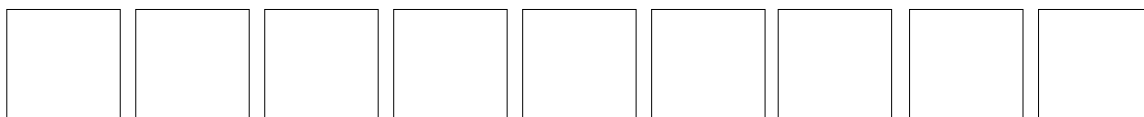

Carbone Ambra Corallo Rosso bordeaux Grigio cenere Nebbia Grigio medio Fumo Ebano

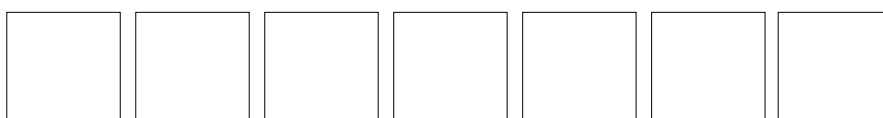

Grigio ombra Piombo Origano Muschio Verde bosco Blu oceano Nero assoluto

Fianco a L terminale gola

In composizioni con isola/penisola si possono utilizzare i fianchi terminali gola mantenendo la stessa estetica frontale anche lateralmente e sul retro.

"L" groove end side panel

In case of isle/peninsula kitchens, groove end side panels can be used to keep the same front look also on side and back.



Disponibile per i seguenti modelli:

- **Bellaria**

Available for models:

- **Bellaria**

Lo spezzone di gola laterale viene conteggiato separatamente e non è incluso nel prezzo del fianco.

The end side panel groove is calculated separately and it's not included in the end side panel price.

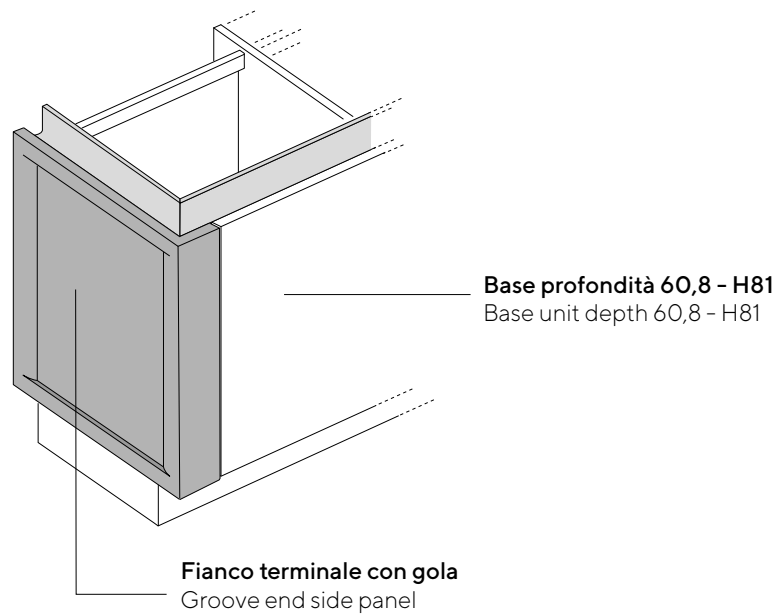

Fianco a L terminale gola

In composizioni con isola/penisola si possono utilizzare i fianchi terminali gola mantenendo la stessa estetica frontale anche lateralmente e sul retro.

"L" groove end side panel

In case of isle/peninsula kitchens, groove end side panels can be used to keep the same front look also on side and back.

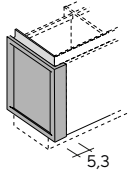

Fianco terminale con gola per sistema H81

Groove end side panel for H81 system

Profondità Depth	Codice Code	0	1	2	3	4	5	6	7	8	9	10	11	12
60,8 (top prof. 63,8)	OBXGL081AL26	-	-	179	-	258	288	302	-	-	-	-	-	-

Gola per fianco terminale (completa di giunzione spigolo)

Groove for end side panel (complete with corner joint)

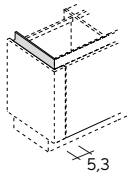

Verso Sense	Profondità Depth	Codice Code	Prezzo Price
SX LH	60,8 (top prof. 63,8)	GLB57066GCS	
DX RH	60,8 (top prof. 63,8)	GLB57066GCD	

Finiture | Finishing

Standard
Standard



Bianco Metal Lavagna

Laccato opaco
Matt lacquered

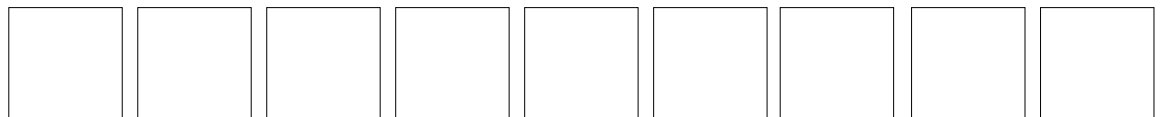

Bianco puro Lino Pergamena Grigio corda Canapa Tabacco Fango Grigio sasso Quarzo

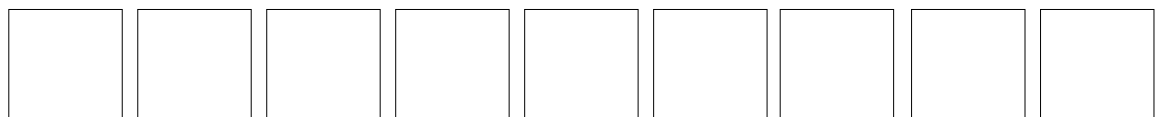

Carbone Ambra Corallo Rosso bordeaux Grigio cenere Nebbia Grigio medio Fumo Ebano

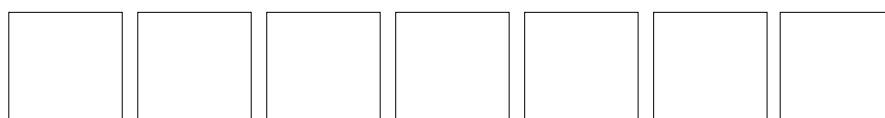

Grigio ombra Piombo Origano Muschio Verde bosco Blu oceano Nero assoluto

